

## INDICE - INDEX

|  |    |
|--|----|
| <b>Colori</b> ( <i>Colours, Couleurs</i> )   | 02 |
| <b>Supplementi</b> ( <i>Additional, Supplements</i> )  | 03 |
| <b>Serie Aurora</b> ( <i>Aurora series, Serie Aurora</i> )   | 04 |
| Elementi fissi ( <i>Fixed element, Eléments fixes</i> )  | 05 |
| Elementi su ruote ( <i>Eléments on castors, Elements mobiles</i> )   | 10 |
| <b>Serie Prestige</b> ( <i>Prestige series, Serie Prestige</i> )   | 14 |
| Elementi fissi ( <i>Fixed element, Eléments fixes</i> )  | 15 |
| Elementi su ruote ( <i>Elements on castors, Elements mobiles</i> )   | 19 |
| <b>Serie Elite</b> ( <i>Elite series, Serie Elite</i> )  | 22 |
| Elementi fissi ( <i>Fixed element, Eléments fixes</i> )  | 23 |
| Elementi su ruote ( <i>Elements on castors, Elements mobiles</i> )   | 27 |
| <b>Mobili colonna</b> ( <i>Tall unit, Meuble colonne</i> )   | 29 |
| <b>Pensili</b> ( <i>Wall units, Armoires murales</i> )   | 30 |
| <b>Piani top</b> ( <i>Worktops, Plans</i> )  | 32 |
| Piani top in laminato ( <i>Laminate worktops, Plans en laminé</i> )  | 32 |
| Lavorazioni top laminato ( <i>Special manufacturing of laminate worktops, Fabrication du plans de travail en laminé</i> )          | 33 |
| Piani top stratificato ( <i>Stratified worktops, Plans en stratifié</i> )  | 34 |
| Lavorazioni top stratificato ( <i>Special manufacturing of stratified worktops, Fabrication du plans de travail en stratifié</i> ) | 35 |
| Piani top in vetro ( <i>Glass worktops, Plans en verre</i> )   | 36 |
| Lavorazioni top vetro ( <i>Special manufacturing of glass worktops, Fabrication du plans de travail en verre</i> )                 | 37 |
| Piani top in acciaio inox ( <i>St. Steel worktops, Plans en inox</i> )   | 38 |
| Piani in corian ( <i>Corian worktops, Plans en Corian</i> )  | 39 |
| Lavorazioni top corian ( <i>Special manufacturing of corian worktops, Fabrication du plans de travail en corian</i> )              | 40 |
| Alzatine ( <i>Backsplashes, Dosserets</i> )  | 41 |
| Piani servomobile ( <i>Tops for mobile elements, Plans pour elements sur roulettes</i> )   | 42 |
| <b>Bacinelle</b> ( <i>Basins, Interieurs de tiroirs</i> )  | 43 |
| <b>Carrelli</b> ( <i>Trolleys, Chariots</i> )  | 45 |
| <b>Sedie</b> ( <i>Chairs, Siège</i> )  | 47 |
| Elementi da combinare ( <i>Elements to combine, Eléments a combiner</i> )  | 48 |
| <b>Aspirazione portatile</b> ( <i>Portable suction, Aspiration portative</i> )   | 49 |
| <b>Amico Box</b> ( <i>Amico box, Amico box</i> )   | 50 |
| <b>Inox lab</b> ( <i>Inox lab, Inox lab</i> )  | 51 |
| <b>Micromotore</b> ( <i>Micromotor, Micromoteur</i> )  | 51 |
| <b>Accessori</b> ( <i>Accessories, Accessoires</i> )   | 52 |
| <b>Condizioni generali di vendita</b> ( <i>Condition of sale, Conditions generales de vente</i> )                                  | 57 |

MOBILI  
FURNITURE  
MEUBLES

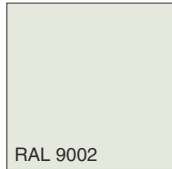

MANIGLIE  
HANDLES  
POIGNEES

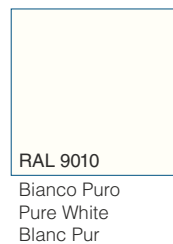
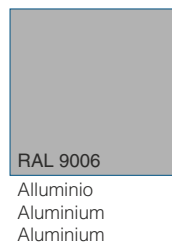
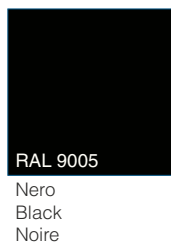
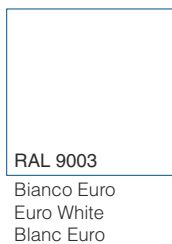
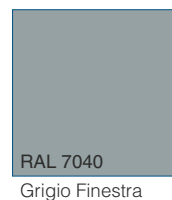
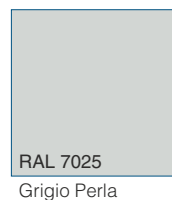
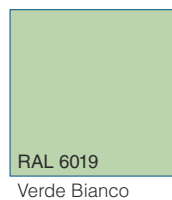
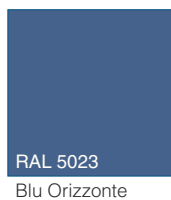
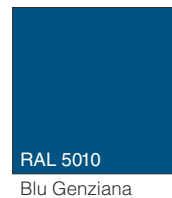
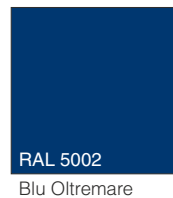
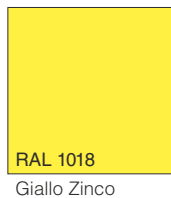
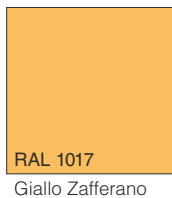

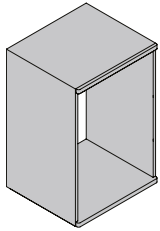

**Mobile (fusto)**  
Item  
Élément

**al pezzo**  
per unit  
chaque pièce

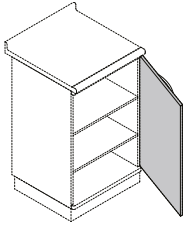

**Porta**  
Door  
Porte

**al pezzo**  
per unit  
chaque pièce

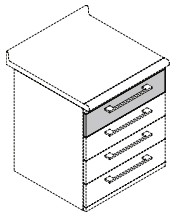

**Frontale**  
Front drawer  
Façade

**al pezzo**  
per unit  
chaque pièce

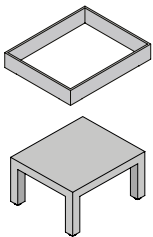

**Zoccolo**  
Plinth  
Socle

**al pezzo**  
per unit  
chaque pièce

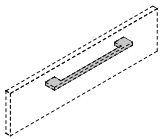

**Maniglia**  
Handle  
Poignée

**al pezzo**  
per unit  
chaque pièce

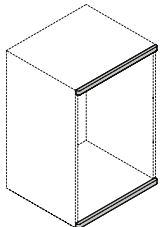

**Liste superiori e inferiori**  
Upper and lower profiles  
Listes inférieurs et supérieurs

**al pezzo**  
per unit  
chaque pièce

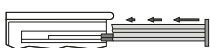

**Supplemento per guide a rientro automatico**  
Additional charge for self-closing system of drawers  
Supplement pour système automatique de glissières

**a coppia**  
per set  
au paire

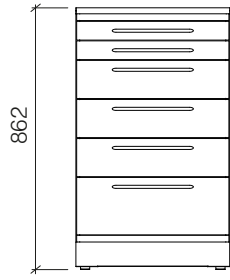

LAMINATO  
LAMINATE  
LAMINE

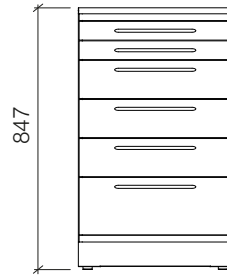

VETRO  
GLASS  
VERRE

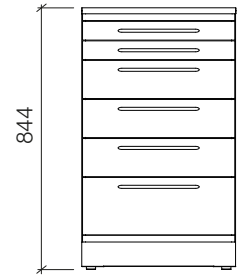

CORIAN  
CORIAN  
CORIAN

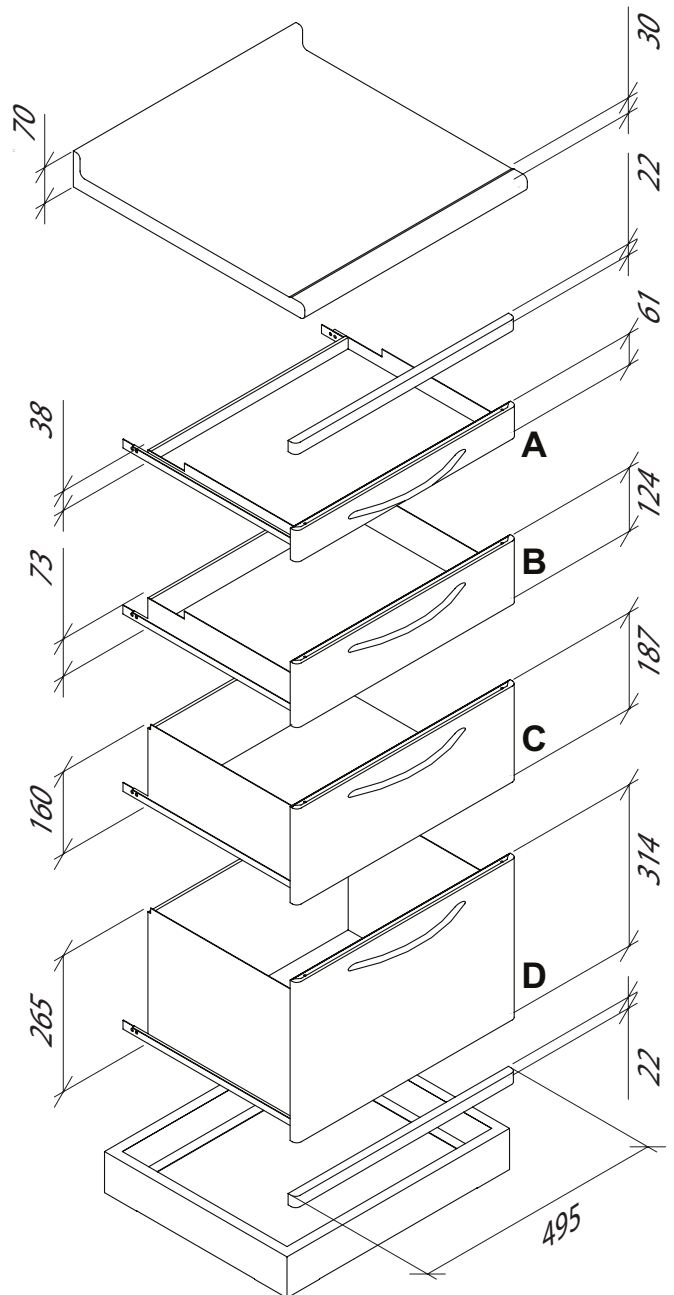
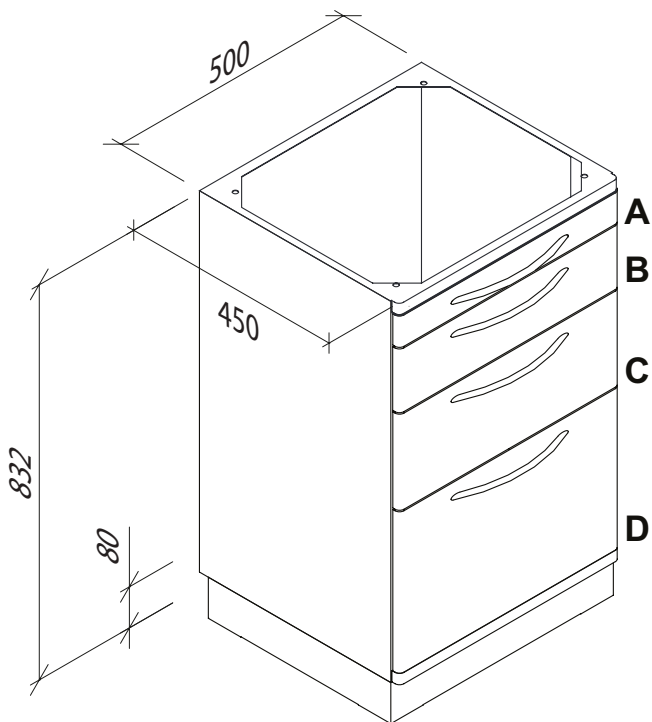



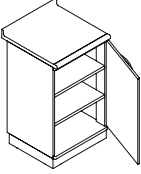
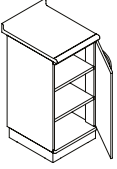
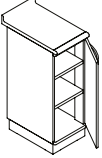
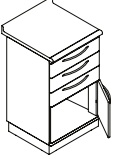
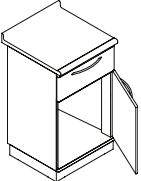
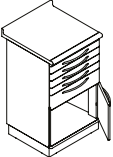
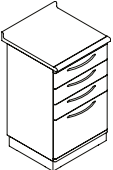

N.B.: Il prezzo è comprensivo di piano

N.B.: The price includes the worktop

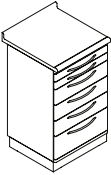
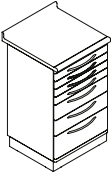
N.B.: Dans le prix est inclus le plan

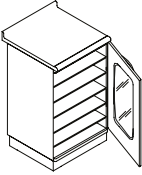
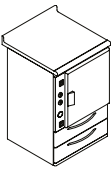
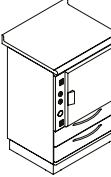
|  |  | Euro                          |                         |                            |
|--|--|-------------------------------|-------------------------|----------------------------|
| Articolo<br>Article  |  | laminato<br>laminat<br>laminé | vetro<br>glass<br>verre | corian<br>corian<br>corian |
|    | <b>Elemento 1 anta - 2 ripiani</b><br>1 door unit - 2 shelves<br>Elément 1 porte - 2 rayons internes   |                               |                         |                            |
|    | <b>Elemento larghezza 40 cm - 1 anta - 2 ripiani</b><br>1 door unit width 40 cm - 2 shelves<br>Elément 1 porte largeur 40 cm - 2 rayons internes   | L.40 x P.47                   | <b>T400</b>             |                            |
|   | <b>Elemento larghezza 30 cm - 1 anta - 2 ripiani</b><br>1 door unit width 30 cm - 2 shelves<br>Elément 1 porte largeur 30 cm - 2 rayons internes   | L.30 x P.47                   | <b>T300</b>             |                            |
|  | <b>Elemento 3 cassetti B - 1 antina</b><br>2 bacinelle - 1 fondo PVC<br>3 B drawers - 1 door unit<br>2 trays - 1 PVC bottom<br>Elément 3 tiroirs B - 1 porte<br>2 intérieurs de tiroirs - 1 fond en PVC                                    |                               | <b>T3P</b>              |                            |
|  | <b>Elemento 1 anta e 1 cassetto a scelta (A / C)</b><br>1 bacinella<br>1 door unit and 1 drawer (A / C) to choose<br>1 tray<br>Elément 1 porte et 1 tiroir (A / C) au choix<br>1 intérieur de tiroirs                                      |                               | <b>T2</b>               |                            |
|  | <b>Elemento 4 cassetti A - 1 B - 1 antina</b><br>3 bacinelle - 2 fondi PVC<br>4 A drawers - 1 B drawers - 1 door unit<br>3 trays - 2 PVC bottoms<br>Elément 4 tiroirs A - 1 tiroir B - 1 porte<br>3 intérieurs de tiroirs - 2 fonds en PVC |                               | <b>T5P</b>              |                            |
|  | <b>Elemento 3 cassetti B - 1 D</b><br>2 bacinelle - 2 fondi PVC<br>3 B drawers - 1 D drawers unit<br>2 trays - 2 PVC bottoms<br>Elément 3 tiroirs B - 1 tiroir D<br>2 intérieurs de tiroirs - 2 fonds en PVC                               |                               | <b>T4</b>               |                            |

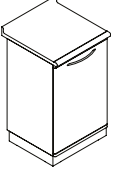
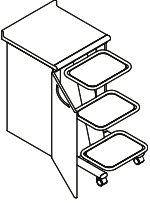
|  |   | Euro                                |                         |                            |
|--|---|-------------------------------------|-------------------------|----------------------------|
|  |   | laminato<br>laminated<br>laminé     | vetro<br>glass<br>verre | corian<br>corian<br>corian |
| Articolo<br>Article  |   |                                     |                         |                            |
|    | <b>Elemento 1 cassetti A - 2 B - 2 C</b><br>3 bacinelle - 2 fondi PVC<br>1 A drawer - 2 B drawers - 2 C drawers unit<br>3 trays - 2 PVC bottoms<br>Élément 1 tiroir A - 2 tiroirs B - 2 tiroirs C<br>3 intérieurs de tiroirs - 2 fonds en PVC   | <b>T5</b>                           |                         |                            |
|    | <b>Elemento 2 cassetti A - 3 B - 1 C</b><br>4 bacinelle - 2 fondi PVC<br>2 A drawers - 3 B drawers - 1 C drawer unit<br>4 trays - 2 PVC bottoms<br>Élément 2 tiroirs A - 3 tiroirs B - 1 tiroir C<br>4 intérieurs de tiroirs - 2 fonds en PVC   | <b>T6</b>                           |                         |                            |
|   | <b>Elemento 4 cassetti A - 2 B - 1 C</b><br>5 bacinelle - 2 fondi PVC<br>4 A drawers - 2 B drawers - 1 C drawer unit<br>5 trays - 2 PVC bottoms<br>Élément 4 tiroirs A - 2 tiroirs B - 1 tiroir C<br>5 intérieurs de tiroirs - 2 fonds en PVC   | <b>T7</b>                           |                         |                            |
|  | <b>Elemento 2 piani estraibili portastrumenti</b><br>antina a scomparsa - 1 B - 1 C<br>1 bacinella - 1 fondo PVC<br>Unit with 2 movable surgical instruments holders<br>disappearance door, 1 B drawer, 1 C drawer<br>1 tray - 1 PVC bottom<br>Élément 2 plans extractibles porte<br>instruments porte escamotable 1 tiroir B - 1 C<br>1 intérieur de tiroirs - 1 fond en PVC | <b>TEM2</b>                         |                         |                            |
|  | <b>Elemento 1 anta - 5 ripiani lamiera forata</b><br>lampada a ultravioletti<br>1 door unit - 5 perforated plate shelves unit U.V. lamp<br>Élément 1 porte - 5 rayons en métal perforée lampe Ultra - Violet  | <b>TUV</b>                          |                         |                            |
|  | <b>Elemento porta autoclave</b><br>(precisare modello) 2 cassetti B - 2 fondi PVC<br>2 B drawers - 2 PVC bottoms drawers housing unit for auto-<br>clave (specify the model)<br>Élément pour autoclave encastrée (préciser le modèle)<br>2 tiroirs B - 2 fonds en PVC   | <b>TAU</b>                          |                         |                            |
|  | <b>Elemento porta autoclave (lunghezza 60)</b><br>(precisare modello) 2 cassetti B - 2 fondi PVC<br>2 B drawers - 2 PVC bottoms drawers housing unit for auto-<br>clave (specify the model - width 60)<br>Élément pour autoclave encastrée (préciser le modèle)<br>2 tiroirs B - 2 fonds en PVC (largeur 60)  | <b>L.60 x P.47</b><br><b>TAU600</b> |                         |                            |

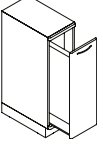
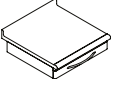
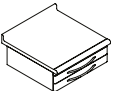
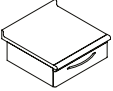
|  |  | Euro                                       |                               |                         |                            |
|--|--|--|-------------------------------|-------------------------|----------------------------|
|  |  | Articolo<br>Article                        | laminato<br>laminat<br>laminé | vetro<br>glass<br>verre | corian<br>corian<br>corian |
|    | <b>Elemento 1 anta con frigorifero</b><br>1 door unit with refrigerator<br>Elément 1 porte avec réfrigérateur  | <b>TFRI</b>                                |                               |                         |                            |
|    | <b>Elemento 1 anta per carrello C3R</b><br>1 door housing unit for C3R trolley<br>Elément vide avec 1 porte pour un chariot C3R                                      | <b>TCT</b>                                 |                               |                         |                            |
|   | <b>Carrello per mobile TCT</b><br>Trolley for TCT element<br>Chariot pour meuble TCT   |  |                               |                         |                            |
|  | <b>Elemento porta asciugamano</b><br>Unit for towels<br>Elément porte essuie-mains   | <i>L.25 x P.47</i><br><b>TASC</b>          |                               |                         |                            |
|  | <b>Cassettiera 1 cassetto tipo A sottopiano</b><br>Drawer unit 1 type A - drawer under shelf<br>Tiroir A complet avec parois et glissières pour mettre sous plan     | <i>L.50 x P.47 x H.18.5</i><br><b>CA1A</b> |                               |                         |                            |
|  | <b>Cassettiera 2 cassetti tipo A sottopiano</b><br>Drawer unit 2 type A - drawers under shelf<br>2 tiroirs A complet avec parois et glissières pour mettre sous plan | <i>L.50 x P.47 x H.24.5</i><br><b>CA2A</b> |                               |                         |                            |
|  | <b>Cassettiera 1 cassetto tipo B sottopiano</b><br>Drawer unit 1 type B - drawer under shelf<br>Tiroir B complet avec parois et glissières pour mettre sous plan     | <i>L.50 x P.47 x H.24.5</i><br><b>CA1B</b> |                               |                         |                            |

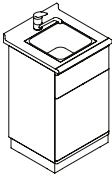
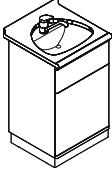
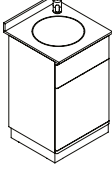
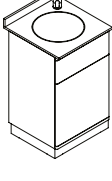
|  |   | Articolo<br>Article | Euro  |
|--|---|---------------------|---|
|    | <b>Elemento lavello</b> con apertura ginocchio<br>vasca inox + miscelatore + portarifiuti<br>Base unit for sink with bend opening<br>stainless steel sink + tap mixer + dustbin<br>Élément lavabo avec porte ouverture au genou<br>vasque en inox + mélangeur + poubelle  | TL1                 | Piano laminato - vasca inox<br>laminated top - inox sink<br>plan laminé - vasque inox |
|  |   | TL2                 | Piano vetro - vasca inox<br>Glass top - inox sink<br>plan verre - vasque inox         |
|    | <b>Elemento lavello</b> con apertura ginocchio<br>piano laminato + vasca ceramica<br>+ miscelatore + portarifiuti<br>Base unit for sink with bend opening<br>laminate top + ceramic sink + tap mixer + dustbin<br>Élément lavabo avec porte ouverture au genou<br>plan en laminé + vasque en ceramique + mélangeur + poubelle | TLVC                |   |
|   | <b>Elemento lavello</b> con apertura ginocchio<br>piano vetro + vasca vetro + miscelatore + portarifiuti<br>Base unit for sink with bend opening<br>glass top + glass sink + tap mixer + dustbin<br>Élément lavabo avec porte ouverture au genou<br>plan en verre + vasque en verre + mélangeur + poubelle                    | TLVV                |   |
|  | <b>Elemento lavello</b> con apertura ginocchio<br>piano corian + vasca corian + miscelatore + portarifiuti<br>Base unit for sink with bend opening<br>corian top + corian sink + tap mixer + dustbin<br>Élément lavabo avec porte ouverture au genou<br>plan en corian + vasque en corian + mélangeur + poubelle              | TLVCO1              | Vasca rotonda<br>Round sink<br>Vasque arrondie  |
|  |   | TLVCO2              | Vasca quadrata<br>Rectangular sink<br>Vasque carrée                                   |

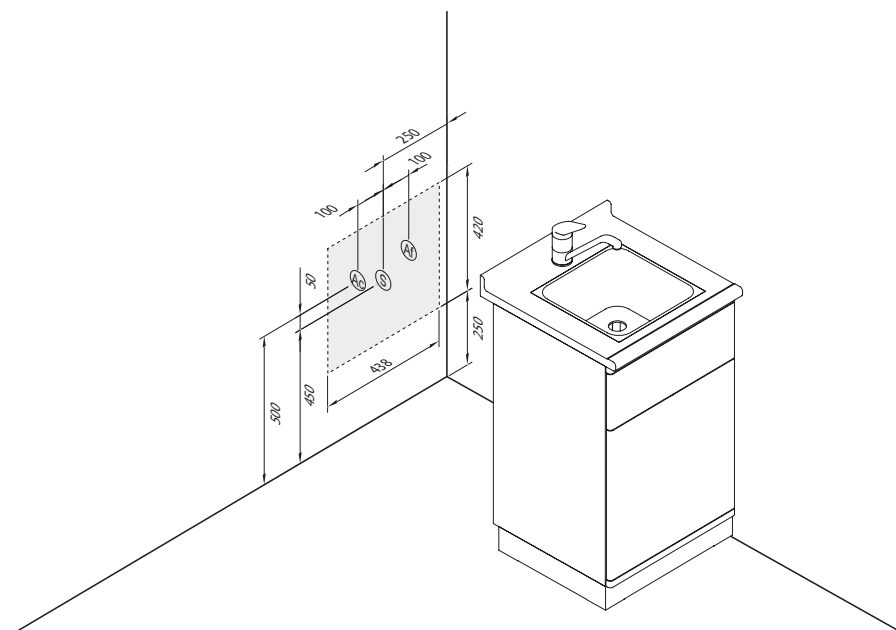





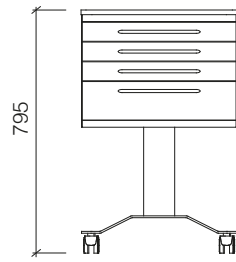

CERAMICA  
CERAMIC  
RESINE

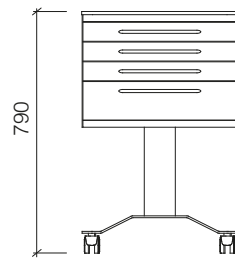

VETRO  
GLASS  
VERRE

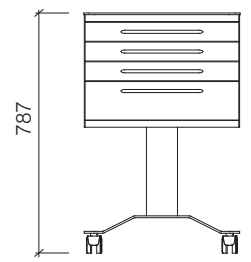

CORIAN  
CORIAN  
CORIAN

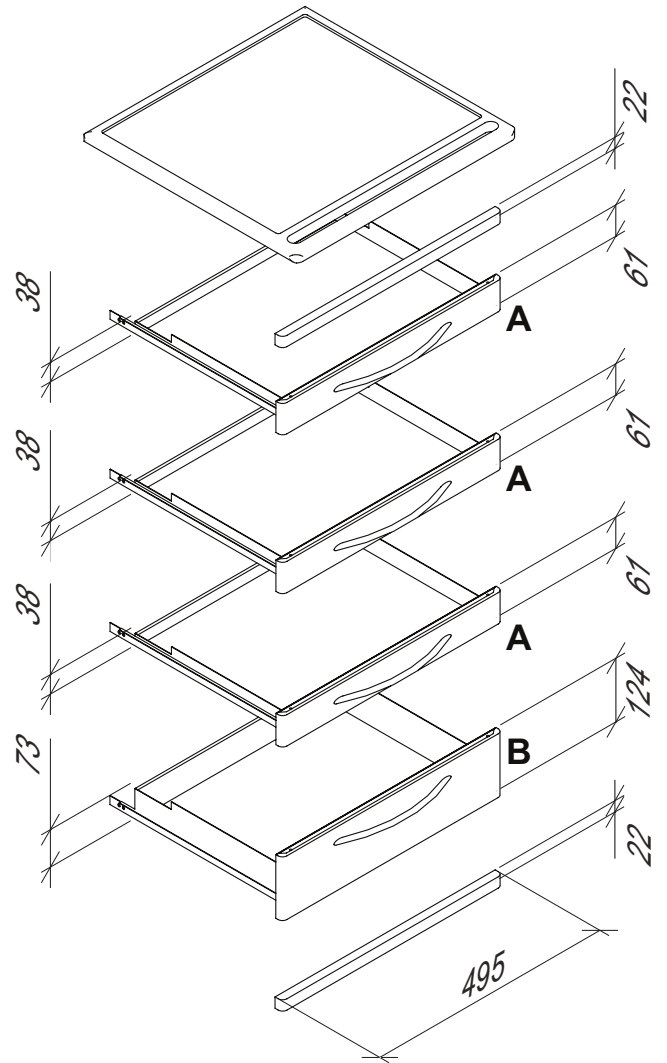
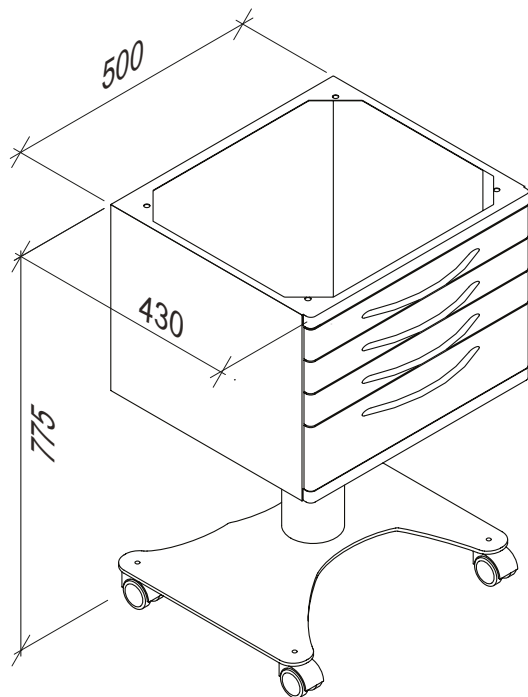

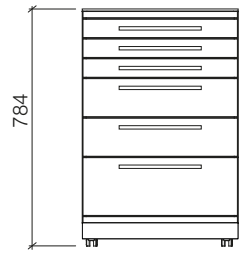
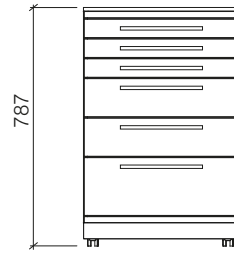
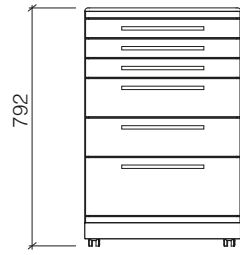

**CERAMICA**  
CERAMIC  
RESINE

**VETRO**  
GLASS  
VERRE

**CORIAN**  
CORIAN  
CORIAN

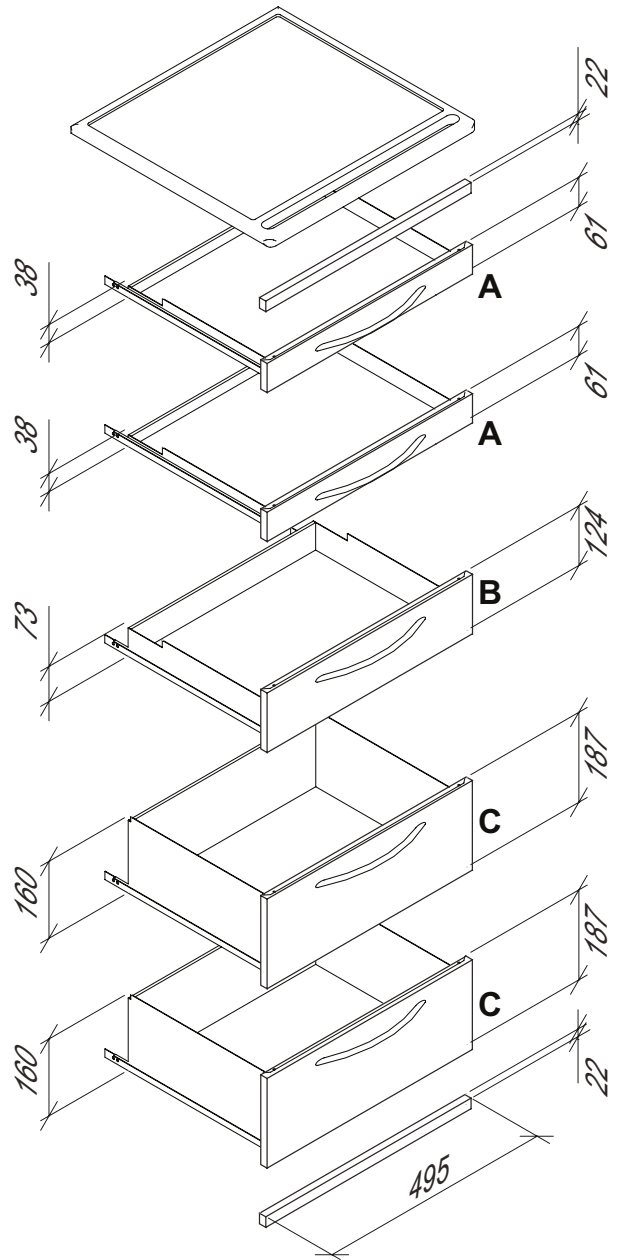
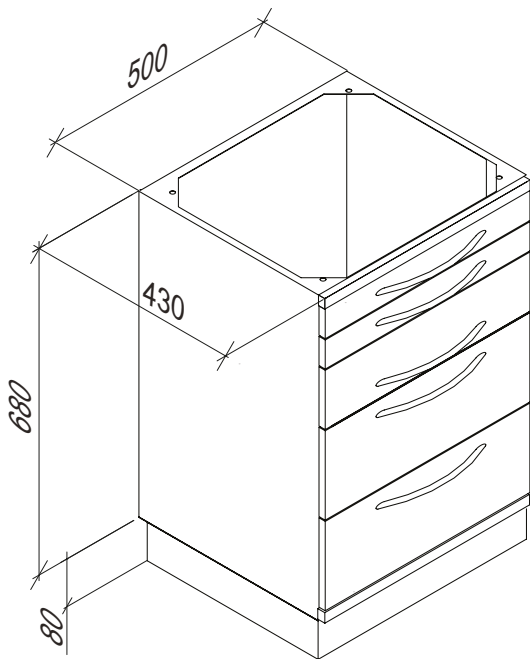



N.B.: Il prezzo è comprensivo di piano

N.B.: The price includes the worktop

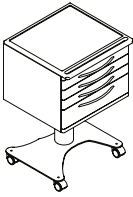
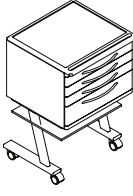
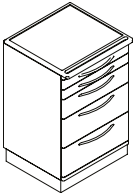
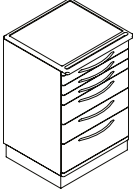
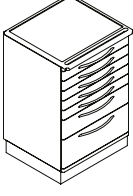
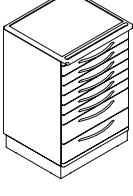
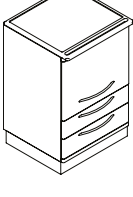
N.B.: Dans le prix est inclus le plan

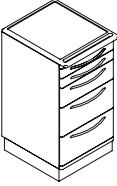
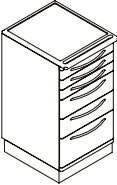
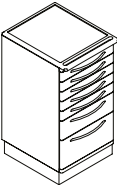
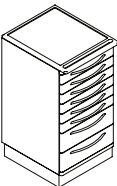
|  |  | Euro                          |                         |                            |
|--|--|-------------------------------|-------------------------|----------------------------|
| Articolo<br>Article  |  | ceramica<br>ceramic<br>resine | vetro<br>glass<br>verre | corian<br>corian<br>corian |
|    | <p><b>Elemento su carrello 3 cassetti A - 1 B</b><br/>                     3 bacinelle - 1 fondo PVC<br/>                     Element on castors 3 A drawers - 1 B drawers<br/>                     3 trays - 1 PVC bottom<br/>                     Élément mobile sur cart avec 3 tiroirs A - 1 B<br/>                     3 intérieurs de tiroirs - 1 fond en PVC</p>  | RC4Z                          |                         |                            |
|    | <p><b>Elemento su carrello 3 cassetti A - 1 B</b><br/>                     3 bacinelle - 1 fondo PVC<br/>                     Element on castors 3 A drawers - 1 B drawers<br/>                     3 trays - 1 PVC bottom<br/>                     Élément mobile sur cart avec 3 tiroirs A - 1 B<br/>                     3 intérieurs de tiroirs - 1 fond en PVC</p>  | RC4K                          |                         |                            |
|   | <p><b>Elemento 2 cassetti A - 1 B - 2 C</b><br/>                     3 bacinelle - 2 fondi PVC<br/>                     2 A drawers - 1 B drawer - 2 C drawers unit<br/>                     3 trays - 2 PVC bottoms<br/>                     Élément 2 tiroirs A - 1 B - 2 C<br/>                     3 intérieurs de tiroirs - 2 fonds en PVC</p>  | RT5                           |                         |                            |
|  | <p><b>Elemento 3 cassetti A - 2 B - 1 C</b><br/>                     4 bacinelle - 2 fondi PVC<br/>                     3 A drawers - 2 B drawers - 1 C drawer unit<br/>                     4 trays - 2 PVC bottoms<br/>                     Élément 3 tiroirs A - 2 B - 1 C<br/>                     4 intérieurs de tiroirs - 2 fonds en PVC</p>  | RT6                           |                         |                            |
|  | <p><b>Elemento 5 cassetti A - 1 B - 1 C</b><br/>                     5 bacinelle - 2 fondi PVC<br/>                     5 A drawers - 1 B drawer - 1 C drawer unit<br/>                     5 trays - 2 PVC bottoms<br/>                     Élément 5 tiroirs A - 1 B - 1 C<br/>                     5 intérieurs de tiroirs - 2 fonds en PVC</p>   | RT7                           |                         |                            |
|  | <p><b>Elemento 6 cassetti A - 2 B</b><br/>                     6 bacinelle - 2 fondi PVC<br/>                     6 A drawers - 2 B drawers<br/>                     6 trays - 2 PVC bottoms<br/>                     Élément 6 tiroirs A - 2 B<br/>                     6 intérieurs de tiroirs - 2 fonds en PVC</p>  | RT8                           |                         |                            |
|  | <p><b>Elemento 2 piani estraibili portastrumenti</b><br/>                     antina a scomparsa 2 cassetti B<br/>                     1 bacinella - 1 fondo in PVC<br/>                     Unit with 2 extractable surgical instruments holders<br/>                     disappearance door 2 B drawers<br/>                     1 tray - 1 PVC bottom<br/>                     Eléments 2 plans extractibles porte<br/>                     instruments porte escamotable<br/>                     2 tiroirs B - 1 intérieur de tiroirs - 1 fond en PVC</p> | RTEM2                         |                         |                            |

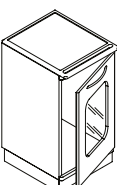
|  |  | Euro                          |                         |                            |
|--|--|-------------------------------|-------------------------|----------------------------|
| Articolo<br>Article  |  | ceramica<br>ceramic<br>resine | vetro<br>glass<br>verre | corian<br>corian<br>corian |
|    | <p><b>Elemento 2 cassetti A - 1 B - 2 C</b><br/>           3 bacinelle - 2 fondi PVC<br/>           3 A drawers - 1 B drawer - 2 C drawers unit<br/>           3 trays - 2 PVC bottoms<br/>           Elément 2 tiroirs A - 1 tiroir B - 2 tiroirs C<br/>           3 intérieurs de tiroirs - 2 fonds en PVC</p>   | SRT5                          |                         |                            |
|    | <p><b>Elemento 3 cassetti A - 2 B - 1 C</b><br/>           4 bacinelle - 2 fondi PVC<br/>           3 A drawers - 2 B drawers - 1 C drawer unit<br/>           4 trays - 2 PVC bottoms<br/>           Elément 3 tiroirs A - 2 tiroirs B - 1 tiroir C<br/>           4 intérieurs de tiroirs - 2 fonds en PVC</p>   | SRT6                          |                         |                            |
|   | <p><b>Elemento 5 cassetti A - 1 B - 1 C</b><br/>           4 bacinelle - 3 fondi PVC<br/>           5 A drawers - 1 B drawer - 1 C drawer unit<br/>           4 trays - 3 PVC bottoms<br/>           Elément 5 tiroirs A - 1 tiroir B - 1 tiroir C<br/>           4 intérieurs de tiroirs - 3 fonds en PVC</p>   | SRT7                          |                         |                            |
|  | <p><b>Elemento 6 cassetti A - 2 B</b><br/>           6 bacinelle - 2 fondi PVC<br/>           6 A drawers - 2 B drawers<br/>           6 trays - 2 PVC bottoms<br/>           Elément 6 tiroirs A - 2 tiroirs B<br/>           6 intérieurs de tiroirs - 2 fonds en PVC</p>  | SRT8                          |                         |                            |
|  | <p><b>Elemento 1 piano estraibile portastrumenti</b><br/>           antina a scomparsa 2 cassetti B<br/>           1 bacinella - 1 fondo PVC<br/>           Unit with 1 extractable surgical instruments holder<br/>           disappearance door 2 B drawers<br/>           1 tray - 1 PVC bottom<br/>           Eléments 1 plan extractibles porte instruments - 2 tiroirs B<br/>           porte escamotable<br/>           1 intérieur de tiroir - 1 fond en PVC</p>   | SRTEM1                        |                         |                            |
|  | <p><b>Elemento 2 piani estraibili portastrumenti</b><br/>           antina a scomparsa 2 cassetti B<br/>           1 bacinella - 1 fondo PVC<br/>           Unit with 2 extractable surgical instruments holders<br/>           disappearance door 2 B drawers<br/>           1 tray - 1 PVC bottom<br/>           Eléments 2 plans extractibles porte instruments - 2 tiroirs B<br/>           porte escamotable<br/>           1 intérieur de tiroir - 1 fond en PVC</p> | SRTEM2                        |                         |                            |
|  | <p><b>Elemento 1 anta porta trays-zirc</b><br/>           1 door element with dispenser for trays-zirc<br/>           Elément avec 1 porte et rayons intérieurs pour trays-zirc</p>  | SRZIRC                        |                         |                            |

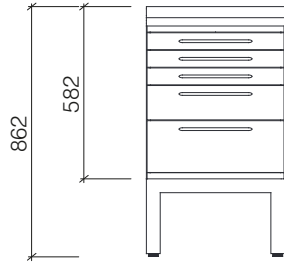

LAMINATO  
LAMINATE  
LAMINE

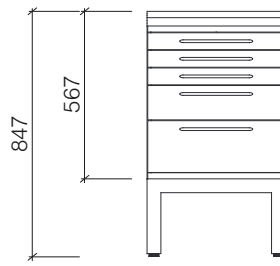

VETRO  
GLASS  
VERRE

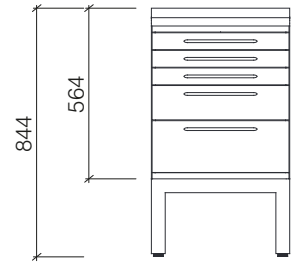

CORIAN  
CORIAN  
CORIAN

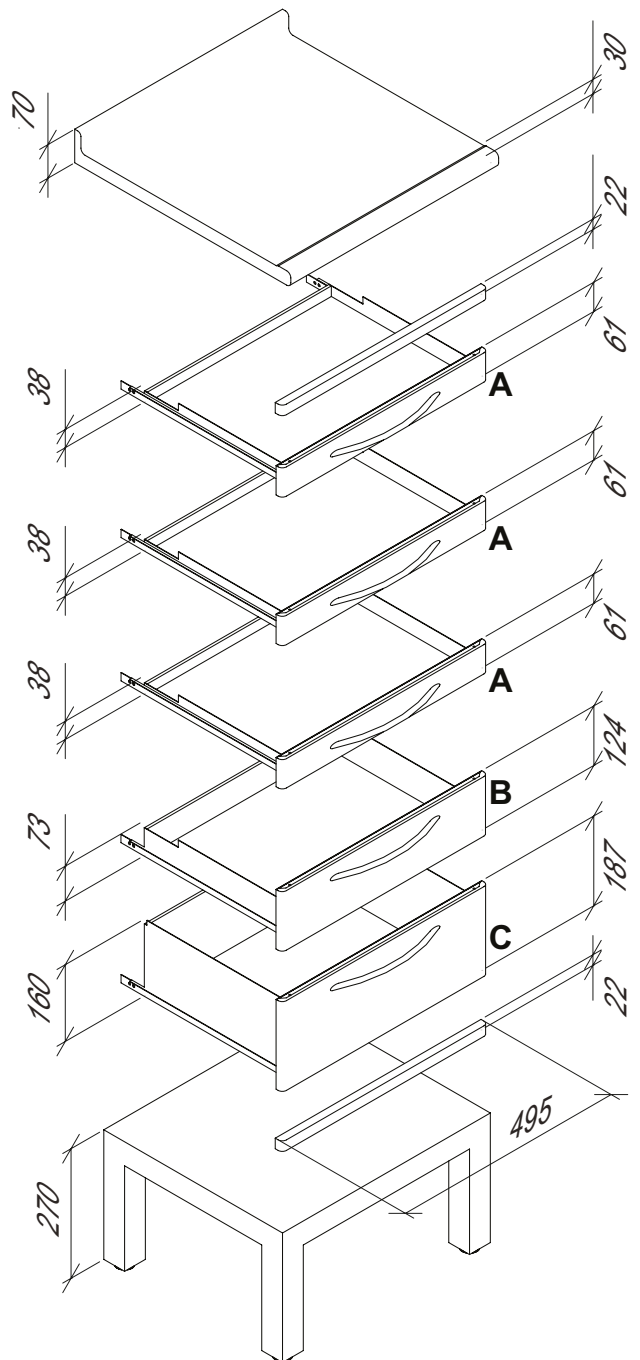
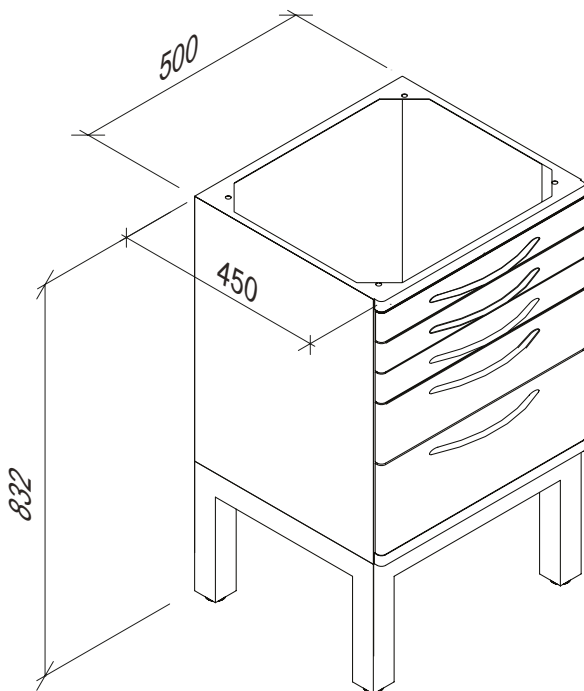

N.B.: Il prezzo è comprensivo di piano top - Le composizioni sono complete di supporto H.28  
cm in acciaio

N.B.: The price includes the worktop - The compositions are completed of stainless steel support h.28

N.B.: Dans le prix est inclus le plan - Les compositions se montent sur base métallique de 28 cm de hauteur

Euro

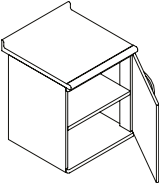
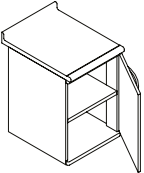
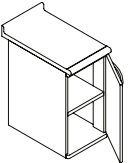
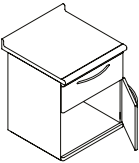
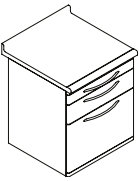
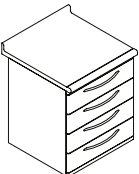
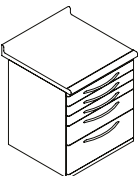
|  |   | Articolo<br>Article | laminato<br>laminat<br>laminé | vetro<br>glass<br>verre | corian<br>corian<br>corian |
|--|---|---------------------|-------------------------------|-------------------------|----------------------------|
|    | <b>Elemento 1 anta - 1 ripiano</b><br>1 door cabinet - 1 shelf<br>Elément 1 porte - 1 rayon interne   | <b>PT</b>           |                               |                         |                            |
|    | <b>Elemento larghezza 40 cm - 1 anta - 1 ripiano</b><br>1 door cabinet width 40 cm - 1 shelf<br>Elément 1 porte largeur 40 cm - 1 rayon interne   | <b>PT400</b>        |                               |                         |                            |
|   | <b>Elemento larghezza 30 cm - 1 anta - 1 ripiano</b><br>1 door cabinet width 30 cm - 1 shelf<br>Elément 1 porte largeur 30 - 1 rayon interne  | <b>PT300</b>        |                               |                         |                            |
|  | <b>Elemento 1 anta e 1 cassetto a scelta (A / C)</b><br>1 bacinella<br>1 door unit and 1 drawer (A / C) to choose<br>1 tray<br>Elément 1 porte et 1 tiroir (A / C) au choix<br>1 intérieur de tiroirs                                     | <b>PT2</b>          |                               |                         |                            |
|  | <b>Elemento 1 cassetto A - 1 B - 1 D</b><br>2 bacinelle- 1 fondo PVC<br>1 A drawer - 1 B drawer - 1 D drawer unit<br>2 trays - 1 PVC bottom<br>Elément 1 tiroir A - 1 tiroir B - 1 tiroir D<br>2 intérieurs de tiroirs - 1 fond en PVC    | <b>PT3</b>          |                               |                         |                            |
|  | <b>Elemento 4 cassetti B</b><br>2 bacinelle- 2 fondi PVC<br>4 B drawers unit<br>2 trays - 2 PVC bottoms<br>Elément 4 tiroirs B<br>2 intérieurs de tiroirs - 2 fonds en PVC  | <b>PT4</b>          |                               |                         |                            |
|  | <b>Elemento 3 cassetti A - 1 B - 1 C</b><br>4 bacinelle - 1 fondo PVC<br>3 A drawers - 1 B drawer - 1 C drawer unit<br>4 trays - 1 PVC bottom<br>Elément 3 tiroirs A - 1 tiroir B - 1 tiroir C<br>4 intérieurs de tiroirs - 1 fond en PVC | <b>PT5</b>          |                               |                         |                            |

PRESTIGE

|  |  | Euro                                 |                         |                            |
|--|--|--------------------------------------|-------------------------|----------------------------|
|  |  | laminato<br>laminatè                 | vetro<br>glass<br>verre | corian<br>corian<br>corian |
| Articolo<br>Article  |  |                                      |                         |                            |
|    | <b>Elemento 4 cassetti A - 2 B</b><br>4 bacinelle - 2 fondi PVC<br>4 A drawers - 2 B drawers unit<br>4 trays - 2 PVC bottoms<br>Élément 4 tiroirs A - 2 tiroirs B<br>4 intérieurs de tiroirs - 2 fonds en PVC  | <b>PT6</b>                           |                         |                            |
|    | <b>Elemento 2 piani estraibili portastrumenti con antina a scomparsa</b><br>1 cassetto B con un fondo PVC<br>Unit with 2 extractable surgical instruments holders<br>disappearance door - 1 B drawer with one PVC bottom<br>Élément 2 plans extractibles porte-instruments porte escamotable- 1 tiroir B avec un fond en PVC | <b>PTM2</b>                          |                         |                            |
|   | <b>Elemento porta autoclave (specificare il modello)</b><br>1 cassetto B con 1 fondo PVC<br>1 B drawer housing unit for autoclave (specify the model)<br>with one PVC bottom<br>Élément pour autoclave encastrée (préciser le model) 1 tiroir B avec un fond en PVC  | <b>PTAU</b>                          |                         |                            |
|  | <b>Elemento porta autoclave (specificare il modello)</b><br>1 cassetto B con 1 fondo PVC (larghezza 60)<br>1 B drawer housing unit for autoclave (specify the model)<br>with one PVC bottom (width 60)<br>Élément pour autoclave encastrée (préciser le model) 1 tiroir B avec un fond en PVC (largeur 60)                   | <i>L.60 x P.47</i><br><b>PTAU600</b> |                         |                            |
|  | <b>Elemento 1 anta con frigorifero</b><br>1 door unit with refrigerator<br>Élément 1 porte avec réfrigérateur  | <b>PTFRIG</b>                        |                         |                            |
|  | <b>Elemento 1 antina - 3 ripiani lamiera forata</b><br>lampada ultravioletti<br>1 door - 3 perforated plate shelves unit<br>U.V. lamp<br>Élément 1 porte - 3 rayons en métal perforée<br>lampe Ultra-Violet  | <b>PTUV</b>                          |                         |                            |

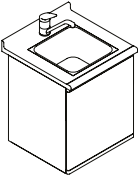
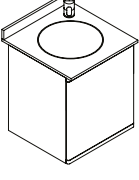
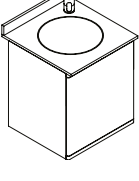

|  |   | Articolo<br>Article | Euro  |
|--|---|---------------------|---|
|    | <b>Elemento lavello con apertura ginocchio</b><br>vasca inox + miscelatore + portarifiuti<br>Base unit for sink with bend opening<br>stainless steel sink + tap mixer + dustbin<br>Élément lavabo avec porte ouverture au genou<br>vasque en inox + mélangeur + poubelle  | <b>PTL1</b>         | Piano laminato - vasca inox<br>laminated top - inox sink<br>plan laminé - vasque inox |
|  |   | <b>PTL2</b>         | Piano vetro - vasca inox<br>Glass top - inox sink<br>plan verre - vasque inox         |
|    | <b>Elemento lavello con apertura ginocchio</b><br>piano laminato + vasca ceramica + miscelatore + portarifiuti<br>Base unit for sink with bend opening+laminated top<br>ceramic sink + tap mixer + dustbin<br>Élément lavabo avec porte ouverture au genou<br>plan en laminé + vasque en ceramique + mélangeur + poubelle | <b>PTLVC</b>        |   |
|   | <b>Elemento lavello con apertura ginocchio</b><br>piano vetro + vasca vetro + miscelatore + portarifiuti<br>Base unit for sink with bend opening<br>glass top + glass sink + tap mixer + dustbin<br>Élément lavabo avec porte ouverture au genou<br>plan en verre + vasque en verre + mélangeur + poubelle                | <b>PTLVV</b>        |   |
|  | <b>Elemento lavello con apertura ginocchio</b><br>piano corian + vasca corian + miscelatore + portarifiuti<br>Base unit for sink with bend opening<br>corian top + corian sink + tap mixer + dustbin<br>Élément lavabo avec porte ouverture au genou<br>plan en corian + vasque en corian + mélangeur + poubelle          | <b>PTLVC01</b>      | Vasca rotonda<br>Round sink<br>vasque arrondie  |
|  |   | <b>PTLVC02</b>      | Vasca quadrata<br>Rectangular sink<br>Vasque carrée                                   |

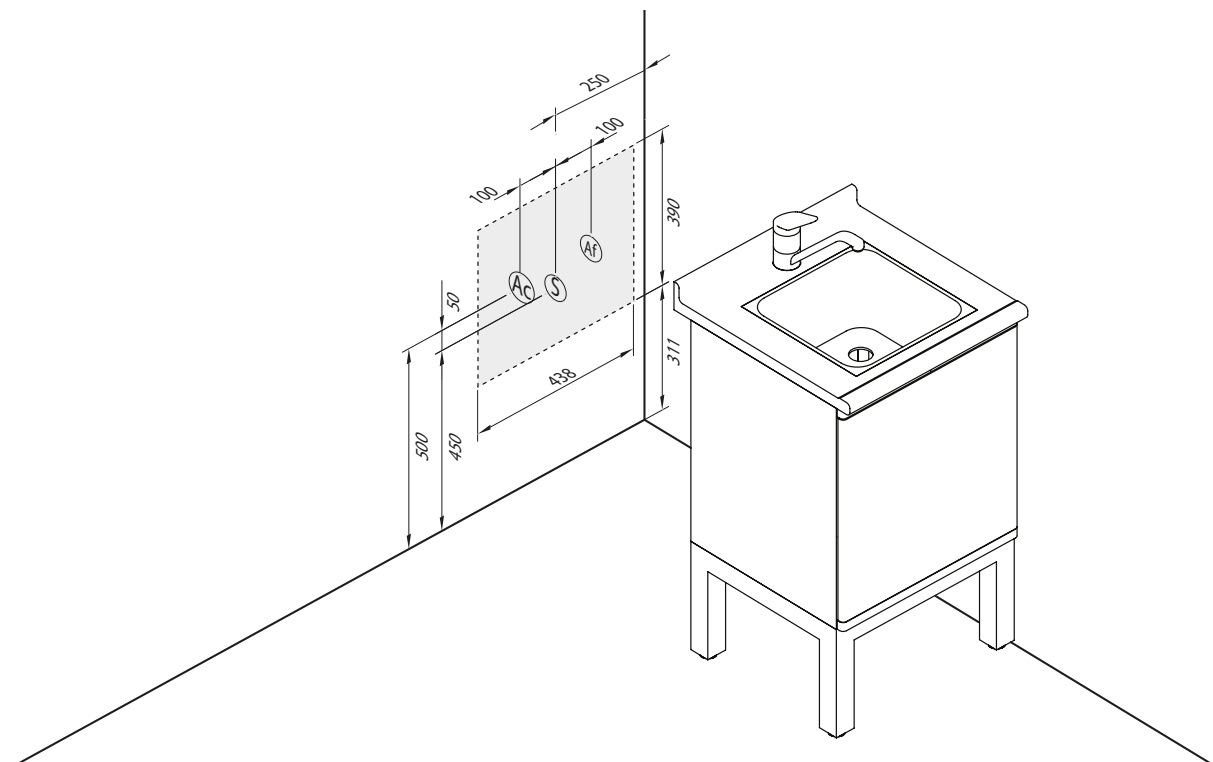

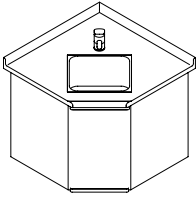
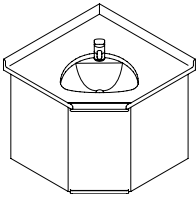
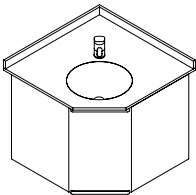
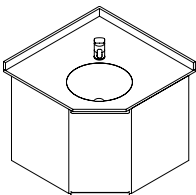
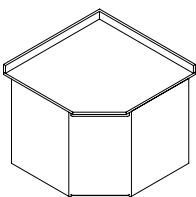
|  |   | Articolo<br>Article                      | Euro  |
|--|---|--|---|
|    | <b>Elementoavello angolare con apertura ginocchio</b><br>vasca inox + miscelatore + portarifiuti<br>Corner base unit for sink with bend opening<br>stainless steel sink + tap mixer + dustbin<br>Elément lavabo en angle avec porte ouverture au genou<br>vasque inox + mélangeur + poubelle  | L.72 x 72 x P.52<br>L.66.5 x 66.5 x P.47 | Piano laminato - vasca inox<br>laminate top - inox sink<br>plan laminé - vasque inox<br><br>Piano vetro - vasca inox<br>Glass top - inox sink<br>plan verre - vasque inox |
|  |   | PTLA1<br><br>PTLA2                       |   |
|    | <b>Elementoavello angolare con apertura ginocchio</b><br>piano laminato + vasca ceramica + miscelatore + portarifiuti<br>Corner base unit for sink with bend opening<br>laminate top + ceramic sink + tap mixer + dustbin<br>Elément lavabo en angle avec porte ouverture au genou<br>plan en laminé + vasque en ceramique + mélangeur + poubelle | L.72 x 72 x P.52<br>L.66.5 x 66.5 x P.47 | PTLAVC  |
|   | <b>Elementoavello angolare</b><br>con apertura ginocchio<br>piano vetro + vasca vetro + miscelatore + portarifiuti<br>Corner base unit for sink with bend opening<br>glass top + glass sink + tap mixer + dustbin<br>Elément lavabo en angle avec porte ouverture au genou<br>plan en verre + vasque en verre + mélangeur + poubelle              | L.72 x 72 x P.52<br>L.66.5 x 66.5 x P.47 | PTLAVV  |
|  | <b>Elementoavello angolare con apertura ginocchio</b><br>piano corian + vasca corian + miscelatore + portarifiuti<br>Corner base unit for sink with bend opening<br>corian top + corian sink + tap mixer + dustbin<br>Elément lavabo en angle avec porte ouverture au genou<br>plan en corian + vasque en corian + mélangeur + poubelle           | L.72 x 72 x P.52<br>L.66.5 x 66.5 x P.47 | PTLAVCO1<br><br>PTLAVCO2  |
|  |   |  | Vasca rotonda<br>Round sink<br>Vasque arrondie<br><br>Vasca quadrata<br>Rectangular sink<br>Vasque carrée   |
|  | <b>Elemento angolare</b><br>Corner base unit<br>Elément angulaire   | L.72 x 72 x P.52<br>L.66.5 x 66.5 x P.47 | PTA<br><br>PTAV<br><br>PTACO  |

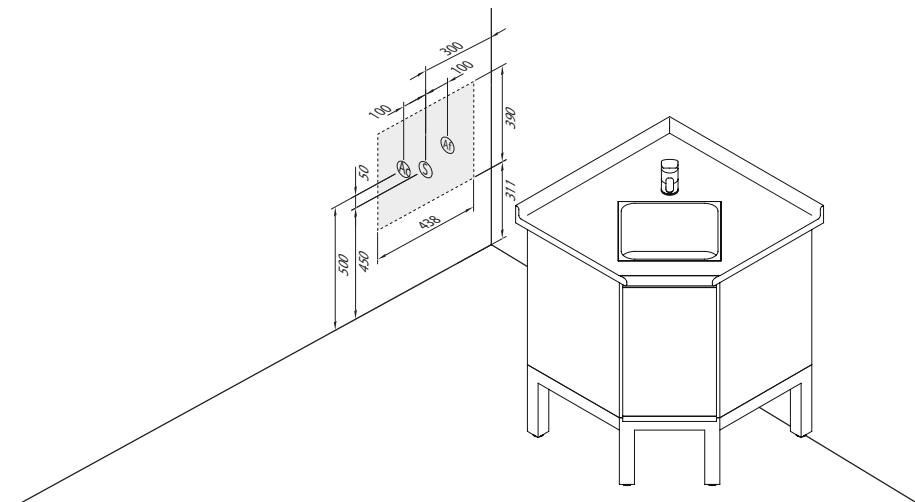

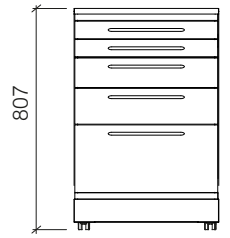
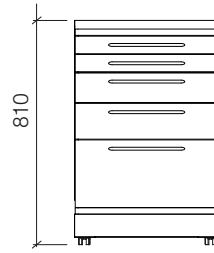
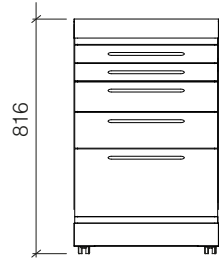

CERAMICA  
CERAMIC  
RESINE

VETRO  
GLASS  
VERRE

CORIAN  
CORIAN  
CORIAN

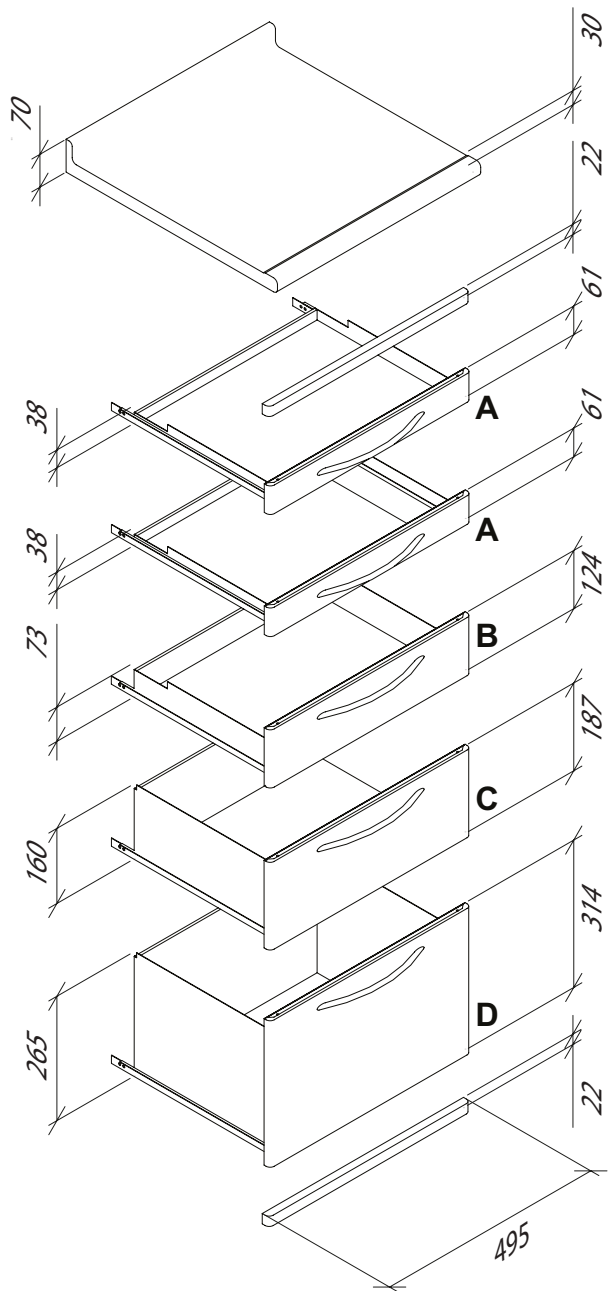
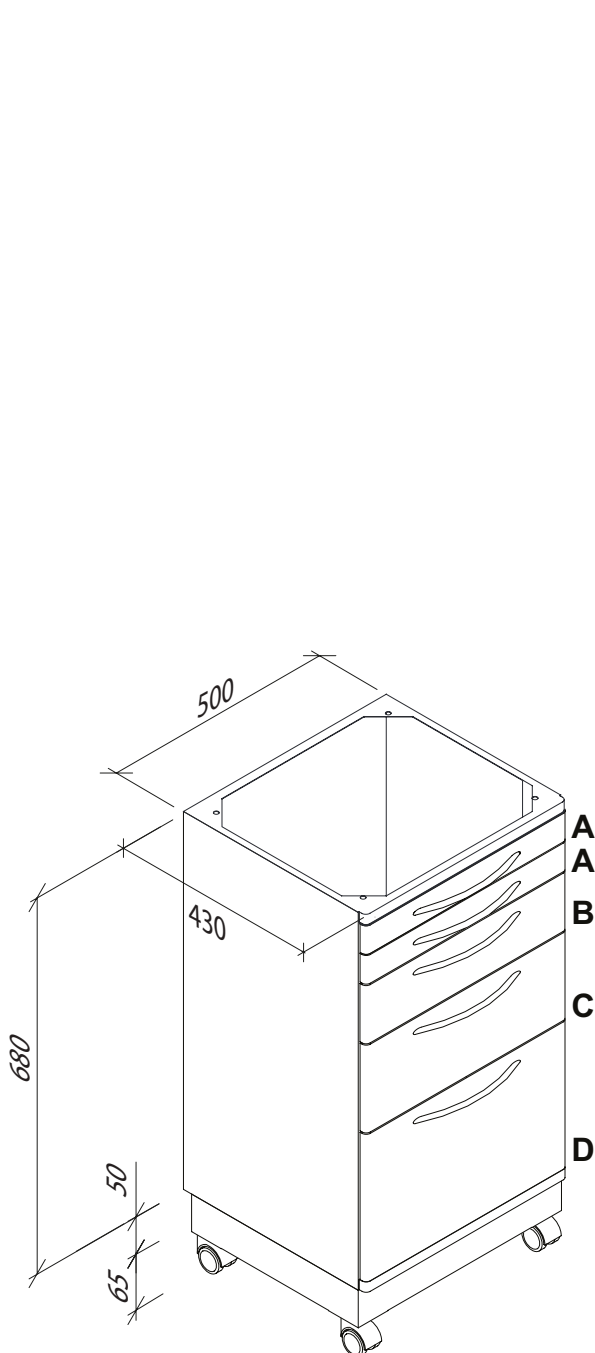

N.B.: Il prezzo è comprensivo di piano

N.B.: The price includes the worktop

N.B.: Dans le prix est inclus le plan

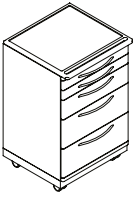
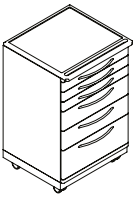
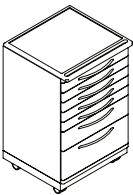
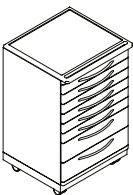
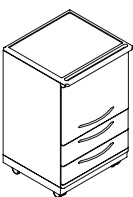
|  |  | Euro                          |                         |                            |
|--|--|-------------------------------|-------------------------|----------------------------|
| Articolo<br>Article  |  | ceramica<br>ceramic<br>resine | vetro<br>glass<br>verre | corian<br>corian<br>corian |
|    | <p><b>Elemento 2 cassetti A - 1 B - 2 C</b><br/>                     3 bacinelle - 2 fondi PVC<br/>                     2 A drawers - 1 B drawer - 2 C drawers unit<br/>                     3 trays - 2 PVC bottoms<br/>                     Élément 2 tiroirs A - 1 B - 2 C<br/>                     3 intérieurs de tiroirs - 2 fonds en PVC</p>  | PRT5                          |                         |                            |
|    | <p><b>Elemento 3 cassetti A - 2 B - 1 C</b><br/>                     4 bacinelle - 2 fondi PVC<br/>                     3 A drawers - 2 B drawers - 1 C drawer unit<br/>                     4 trays - 2 PVC bottoms<br/>                     Élément 3 tiroirs A - 2 B - 1 C<br/>                     4 intérieurs de tiroirs - 2 fonds en PVC</p>  | PRT6                          |                         |                            |
|   | <p><b>Elemento 5 cassetti A - 1 B - 1 C</b><br/>                     5 bacinelle - 2 fondi PVC<br/>                     5 A drawers - 1 B drawer - 1 C drawer unit<br/>                     5 trays - 2 PVC bottoms<br/>                     Élément 5 tiroirs A - 1 B - 1 C<br/>                     5 intérieurs de tiroirs - 2 fonds en PVC</p>   | PRT7                          |                         |                            |
|  | <p><b>Elemento 6 cassetti A - 2 B</b><br/>                     5 bacinelle - 3 fondi PVC<br/>                     6 A drawers - 2 B drawers unit<br/>                     5 trays - 3 PVC bottoms<br/>                     Élément 6 tiroirs A - 2 B<br/>                     5 intérieurs de tiroirs - 3 fonds en PVC</p>   | PRT8                          |                         |                            |
|  | <p><b>Elemento con 2 piani estraibili portastrumenti</b><br/>                     antina a scomparsa - 2 cassetti B<br/>                     1 bacinella- 1 fondo PVC<br/>                     Unit with 2 extractables surgical instruments holders<br/>                     disappearance door 2B drawer<br/>                     1 tray- 1 PVC bottom<br/>                     Élément avec 2 plans extractibles porte-instruments<br/>                     porte escamotable 2 tiroirs B<br/>                     1 intérieur de tiroirs - 1 fond en PVC</p> | PRTEM2                        |                         |                            |

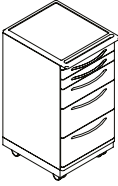
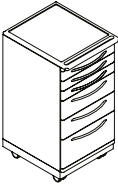
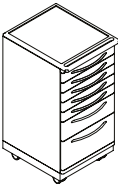
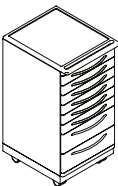
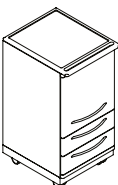
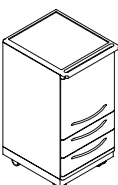
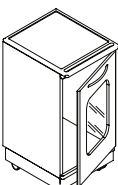
|  |  | Euro                           |                         |                            |
|--|--|--------------------------------|-------------------------|----------------------------|
|  |  | ceramica<br>ceramica<br>resine | vetro<br>glass<br>verre | corian<br>corian<br>corian |
| Articolo<br>Article  |  |                                |                         |                            |
|    | <p><b>Elemento 2 cassetti A - 1 B - 2 C</b><br/>           3 bacinelle - 2 fondi PVC<br/>           2 A drawers - 1 B drawer - 2 C drawers unit<br/>           3 trays - 2 PVC bottoms<br/>           Elément 2 tiroirs A - 1 B - 2 C<br/>           3 intérieurs de tiroirs - 2 fonds en PVC</p>  | PSRT5                          |                         |                            |
|    | <p><b>Elemento 3 cassetti A - 2 B - 1 C</b><br/>           4 bacinelle - 2 fondi PVC<br/>           3 A drawers - 2 B drawers - 1 C drawer unit<br/>           4 trays - 2 PVC bottoms<br/>           Elément 3 tiroirs A - 2 B - 1 C<br/>           4 intérieurs de tiroirs - 2 fonds en PVC</p>  | PSRT6                          |                         |                            |
|   | <p><b>Elemento 5 cassetti A - 1 B - 1 C</b><br/>           4 bacinelle - 3 fondi PVC<br/>           5 A drawers - 1 B drawer - 1 C drawer unit<br/>           4 trays - 3 PVC bottoms<br/>           Elément 5 tiroirs A - 1 B - 1 C<br/>           4 intérieurs de tiroirs - 3 fonds en PVC</p>   | PSRT7                          |                         |                            |
|  | <p><b>Elemento 6 cassetti A - 2 B</b><br/>           6 bacinelle - 2 fondi PVC<br/>           6 A drawers - 2 B drawers unit<br/>           6 trays - 2 PVC bottoms<br/>           Elément 6 tiroirs A - 2 B<br/>           6 intérieurs de tiroirs - 2 fonds en PVC</p>   | PSRT8                          |                         |                            |
|  | <p><b>Elemento 1 piano estraibile portastrumenti</b><br/>           antina a scomparsa 2 cassetti B<br/>           1 bacinella- 1 fondo PVC<br/>           Unit with 1 extractable surgical instruments holder<br/>           disappearance door 2 B drawers<br/>           1 tray- 1 PVC bottom<br/>           Elément 1 plan extractible porte - instruments<br/>           porte escamotable - 2 tiroirs B<br/>           1 interieur de tiroirs - 1 fond en PVC</p>    | PSRTEM1                        |                         |                            |
|  | <p><b>Elemento 2 piani estraibili portastrumenti</b><br/>           antina a scomparsa 2 cassetti B<br/>           1 bacinella- 1 fondo PVC<br/>           Unit with 2 extractables surgical instruments holder<br/>           disappearance door 2 B drawers<br/>           1 tray- 1 PVC bottom<br/>           Elément 2 plans extractibles porte - instruments<br/>           porte escamotable - 2 tiroirs B<br/>           1 interieur de tiroirs - 1 fond en PVC</p> | PSRTEM2                        |                         |                            |
|  | <p><b>Elemento 1 anta porta trays-zirc</b><br/>           1 door element with dispenser for trays-zirc<br/>           Elément avec 1 porte et rayons intérieurs pour trays-zirc</p>  | PSRZIRC                        |                         |                            |

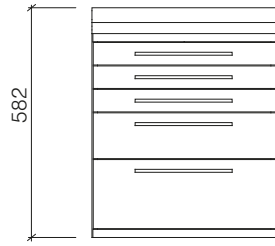

LAMINATO  
LAMINATE  
LAMINE

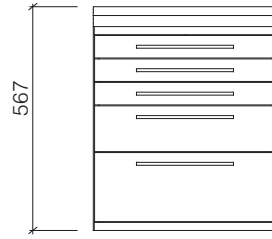

VETRO  
GLASS  
VERRE

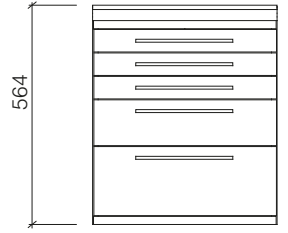

CORIAN  
CORIAN  
CORIAN

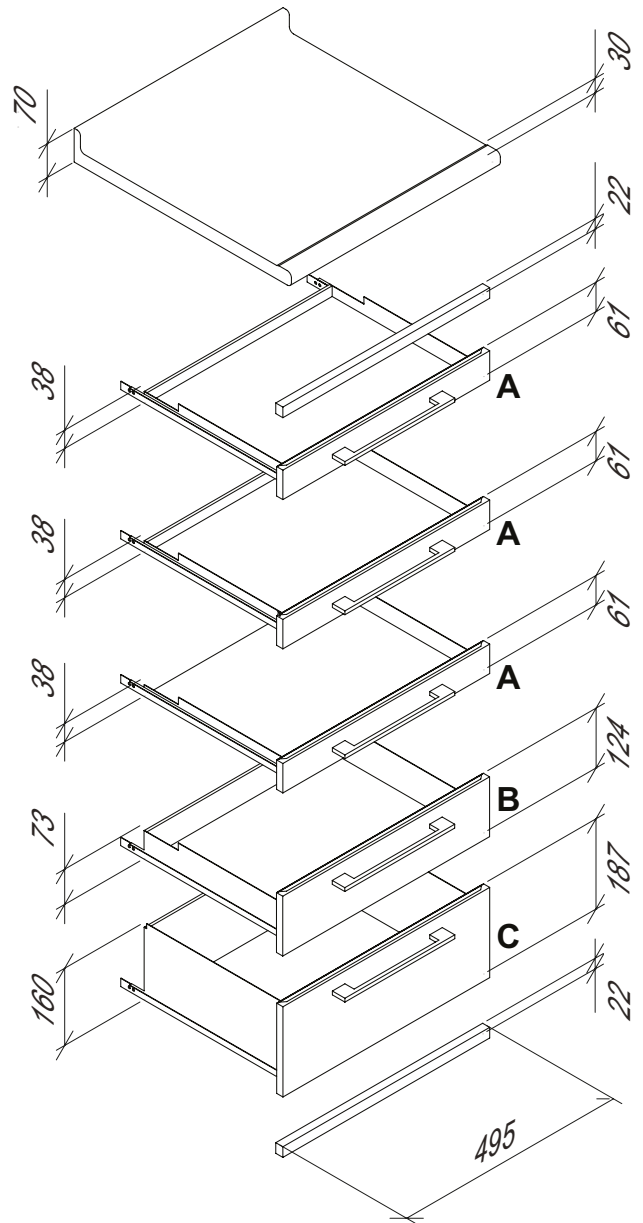
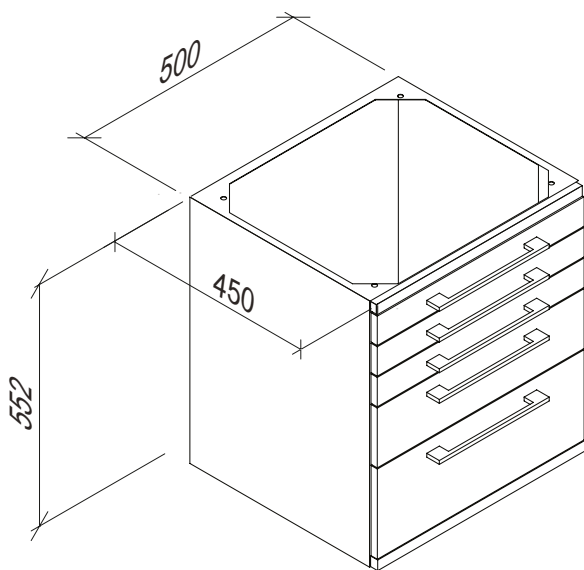

N.B.: Il prezzo è comprensivo di piano top - Mobili dotati di guide con rientro automatico

N.B.: The price includes the worktop - Elements with self-closing system of drawers

N.B.: Dans le prix est inclus le plan - Eléments avec système automatique de glissières

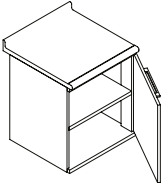
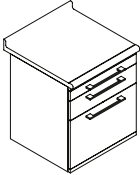
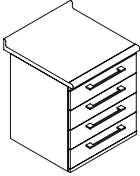
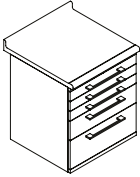
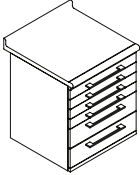
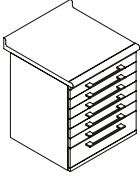
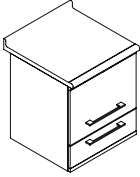
|   |   | Euro                          |                         |                            |
|---|---|-------------------------------|-------------------------|----------------------------|
| Articolo<br>Article   |   | laminato<br>laminat<br>laminé | vetro<br>glass<br>verre | corian<br>corian<br>corian |
|    | <b>Elemento un anta - 1 ripiano</b><br>1 door unit- 1 shelf<br>Elément 1 porte - 1 rayon interne  |                               |                         |                            |
|    | <b>Elemento 1 cassetto A-1 B- 1 D</b><br>2 bacinelle - 1 fondo PVC<br>1 A drawer - 1 B drawer - 1 D drawer unit<br>2 trays- 1 PVC bottom<br>Elément 1 tiroir A - 1 B - 1 D<br>2 intérieurs de tiroirs - 1 fond en PVC   |                               |                         |                            |
|   | <b>Elemento 4 cassetti B</b><br>2 bacinelle - 2 fondi in PVC<br>4 B drawers unit<br>2 trays - 2 PVC bottoms<br>Elément 4 tiroirs B<br>2 intérieurs de tiroirs- 2 fonds en PVC   |                               |                         |                            |
|  | <b>Elemento 3 cassetti A- 1 B - 1C</b><br>4 bacinelle - 1 fondo PVC<br>3 Adrawers - 1 B - 1 C unit<br>4 trays - 1 PVC bottom<br>Elément 3 tiroirs A - 1 B - 1 C<br>4 intérieurs de tiroirs - 1 fond en PVC  |                               |                         |                            |
|  | <b>Elemento 4 cassetti A - 2 B</b><br>4 bacinelle - 2 fondi PVC<br>4 A drawers - 2 B unit<br>4 trays - 2 PVC bottoms<br>Elément 4 tiroirs A - 2 B<br>4 intérieurs de tiroirs - 2 fonds en PVC   |                               |                         |                            |
|  | <b>Elemento 6 cassetti A - 1 B</b><br>5 bacinelle - 2 fondi PVC<br>6 A drawers - 1 B unit<br>5 trays - 2 PVC bottoms<br>Elément 6 tiroirs A - 1 B<br>5 intérieurs de tiroirs - 2 fonds en PVC   |                               |                         |                            |
|  | <b>Elemento con piani estraibili portastrumenti antina a scomparsa 1 cassetto B</b><br>1 fondo in PVC<br>Unit with movable surgical instruments holders disappearance door 1 B drawer - 1 PVC bottom<br>Elément avec plans extractable porte - instruments porte escamotable 1 tiroir B - 1 fond en PVC |                               |                         |                            |

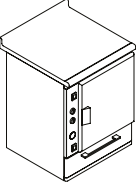
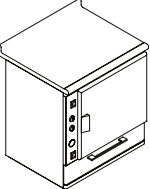
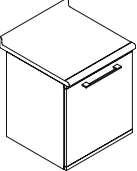
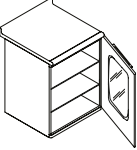
|  |  | Euro                                 |                         |                            |
|--|--|--------------------------------------|-------------------------|----------------------------|
|  |  | laminato<br>laminated<br>laminé      | vetro<br>glass<br>verre | corian<br>corian<br>corian |
| Articolo<br>Article  |  |                                      |                         |                            |
|    | <p><b>Elemento porta autoclave</b> (precisare modello)<br/>1 cassetti B - 1 fondo PVC<br/>1 B drawer - 1 PVC bottom housing unit for autoclave (specify the model)<br/>Elément pour autoclave encastrée (préciser le modèle)<br/>1 tiroir B - 1 fond en PVC</p>  | <b>ETAU</b>                          |                         |                            |
|    | <p><b>Elemento porta autoclave</b> (precisare modello)<br/>1 cassetti B - 1 fondo PVC (larghezza 60 cm)<br/>1 B drawer - 1 PVC bottom housing unit for autoclave (specify the model, width 60 cm)<br/>Elément pour autoclave encastrée (préciser le modèle)<br/>1 tiroir B - 1 fond en PVC (largeur 60 cm)</p> | <i>L.60 x P.47</i><br><b>ETAU600</b> |                         |                            |
|   | <p><b>Elemento 1 anta con frigorifero</b><br/>1 door unit with refrigerator<br/>Elément 1 porte avec réfrigérateur</p>   | <b>ETFRIG</b>                        |                         |                            |
|  | <p><b>Elemento 1 antina - 3 ripiani lamiera forata</b><br/>lampada ultravioletti<br/>1 door - 3 perforated plates shelves unit U.V. lamp<br/>Elément 1 porte - 3 rayons en métal perforée<br/>lampe Ultra Violet</p>   | <b>ETUV</b>                          |                         |                            |

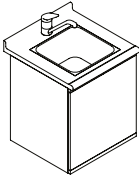
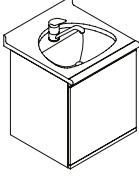
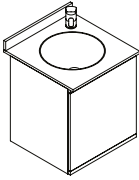
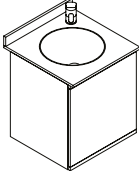

|   |   | Articolo<br>Article | Euro  |
|---|---|---------------------|---|
|    | <p><b>Elemento lavello con apertura ginocchio</b><br/>vasca inox + miscelatore + portarifiuti<br/>Base unit for sink with bend opening<br/>stainless steel sink + tap mixer + dustbin<br/>Elément lavabo avec porte ouverture au genou<br/>vasque en inox + mélangeur + poubelle</p>  | <b>ETL1</b>         | Piano laminato - vasca inox<br>laminated top - inox sink<br>plan laminé - vasque inox |
|   |   | <b>ETL2</b>         | Piano vetro - vasca inox<br>Glass top - inox sink<br>plan verre - vasque inox         |
|    | <p><b>Elemento lavello con apertura ginocchio</b><br/>piano laminato + vasca ceramica + miscelatore + portarifiuti<br/>Base unit for sink with bend opening<br/>laminated top + ceramic sink + tap mixer + dustbin<br/>Elément lavabo avec porte ouverture au genou<br/>plan en laminé + vasque en ceramique + mélangeur + poubelle</p> | <b>ETLVC</b>        |   |
|   | <p><b>Elemento lavello con apertura ginocchio</b><br/>piano vetro + vasca vetro + miscelatore + portarifiuti<br/>Base unit for sink with bend opening<br/>glass top + glass sink + tap mixer + dustbin<br/>Elément lavabo avec porte ouverture au genou<br/>plan en verre + vasque en verre + mélangeur + poubelle</p>                  | <b>ETLVV</b>        |   |
|  | <p><b>Elemento lavello con apertura ginocchio</b><br/>piano corian + vasca corian + miscelatore + portarifiuti<br/>Base unit for sink with bend opening<br/>corian top + corian sink + tap mixer + dustbin<br/>Elément lavabo avec porte ouverture au genou<br/>plan en corian + vasque en corian + mélangeur + poubelle</p>            | <b>ETLVC01</b>      | Vasca rotonda<br>Round sink<br>Vasque arrondie  |
|   |   | <b>ETLVC02</b>      | Vasca quadrata<br>Rectangular sink<br>Vasque carrée                                   |

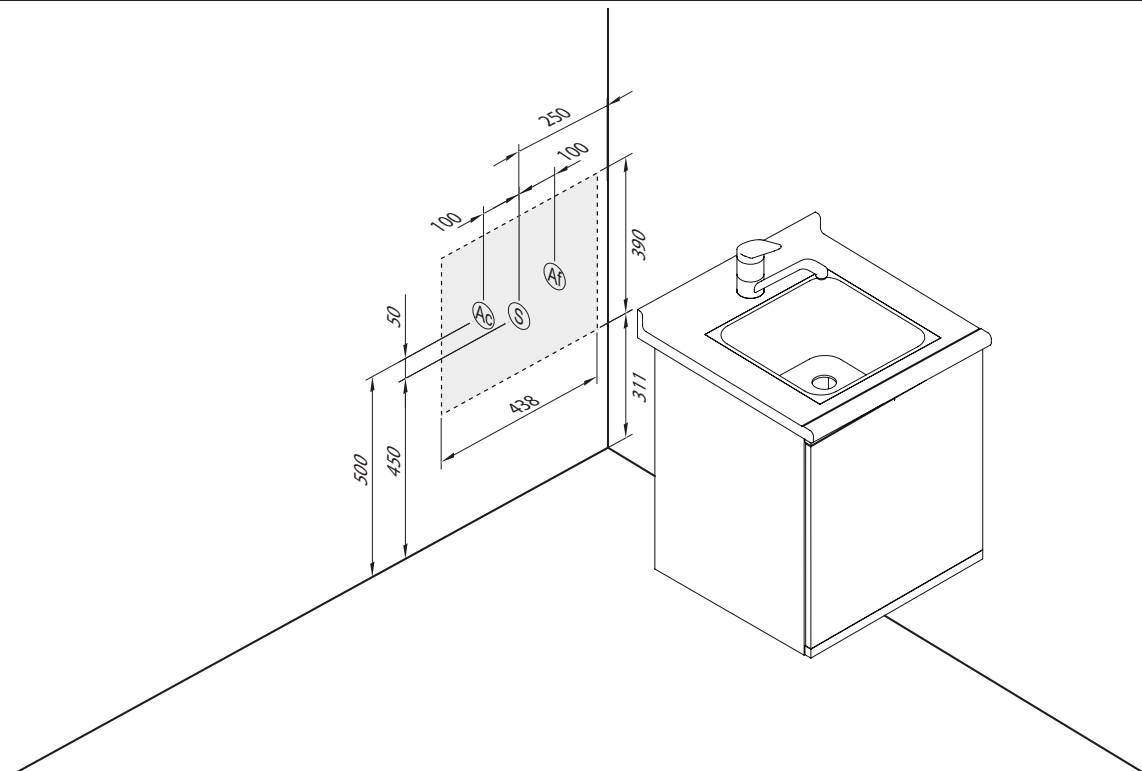

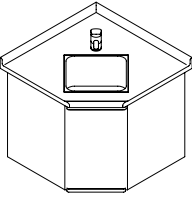
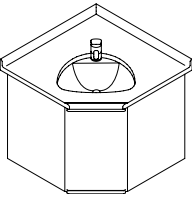
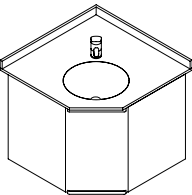
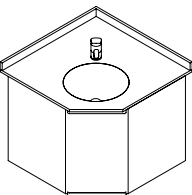
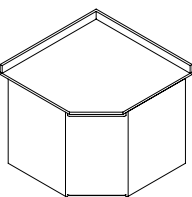
|  |  | Articolo<br>Article                      | Euro  |
|--|--|--|---|
|    | <p><b>Elementoavello angolare</b> con apertura ginocchio<br/>vasca inox + miscelatore + portarifiuti<br/>Corner base unit for sink with bend opening<br/>stainless steel sink + tap mixer + dustbin<br/>Elément lavabo en angle avec porte ouverture au genou<br/>vasque en inox + mélangeur + poubelle</p>  | L.72 x 72 x P.52<br>L.66.5 x 66.5 x P.47 | <p><b>ETLA1</b><br/>Piano laminato - vasca inox<br/>laminated top - inox sink<br/>plan laminé - vasque inox</p> <p><b>ETLA2</b><br/>Piano vetro - vasca inox<br/>Glass top - inox sink<br/>plan verre - vasque inox</p> |
|  |  |  |   |
|    | <p><b>Elementoavello angolare</b> con apertura ginocchio<br/>piano laminato + vasca ceramica + miscelatore + portarifiuti<br/>Corner base unit for sink with bend opening<br/>laminated worktop + ceramic sink + tap mixer + dustbin<br/>Elément lavabo en angle avec porte ouverture au genou<br/>plan en laminé + vasque en ceramique + mélangeur + poubelle</p> | L.72 x 72 x P.52<br>L.66.5 x 66.5 x P.47 | <b>ETLAVC</b>   |
|   | <p><b>Elementoavello angolare</b> con apertura ginocchio<br/>vasca vetro + miscelatore + portarifiuti<br/>Corner base unit for sink with bend opening<br/>glass sink + tap mixer + dustbin<br/>Elément lavabo en angle avec porte ouverture au genou, plan<br/>en verre + vasque en verre + mélangeur + poubelle</p>   | L.72 x 72 x P.52<br>L.66.5 x 66.5 x P.47 | <b>ETLAVV</b>   |
|  | <p><b>Elementoavello angolare</b> con apertura ginocchio<br/>vasca corian + miscelatore + portarifiuti<br/>Corner base unit for sink with bend opening<br/>corian sink + tap mixer + dustbin<br/>Elément lavabo en angle avec porte ouverture au genou<br/>plan en corian + vasque en corian + mélangeur + poubelle</p>  | L.72 x 72 x P.52<br>L.66.5 x 66.5 x P.47 | <b>ETLAVCO1</b><br>Vasca rotonda<br>Round sink<br>Vasque arrondie   |
|  |  |  | <b>ETLAVCO2</b><br>Vasca quadrata<br>Rectangular sink<br>Vasque carrée  |
|  | <p><b>Elemento angolare</b><br/>Corner base unit<br/>Elément angulaire</p>   | L.72 x 72 x P.52<br>L.66.5 x 66.5 x P.47 | <b>ETA</b>  |
|  |  |  | <b>ETAV</b>   |
|  |  |  | <b>ETACO</b>  |

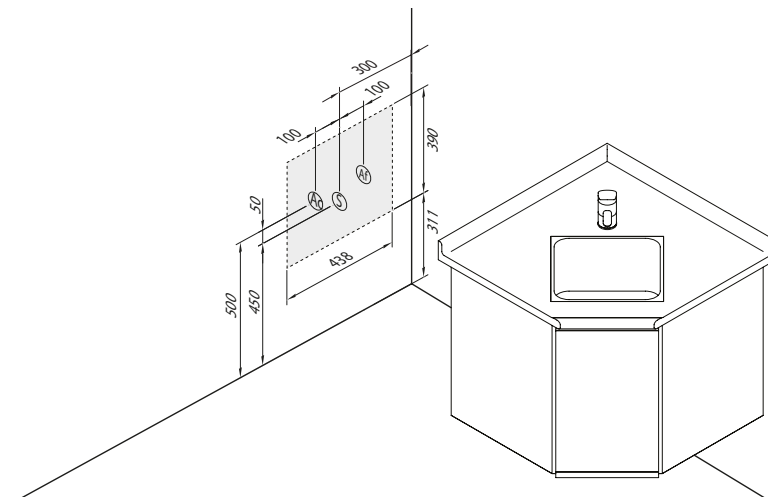

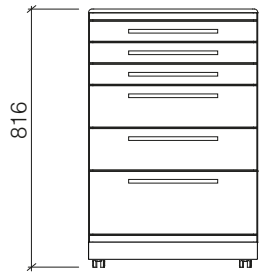

**CERAMICA**  
CERAMIC  
RESINE

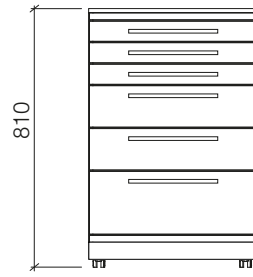

**VETRO**  
GLASS  
VERRE

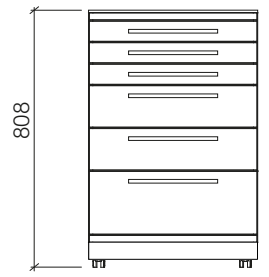

**CORIAN**  
CORIAN  
CORIAN

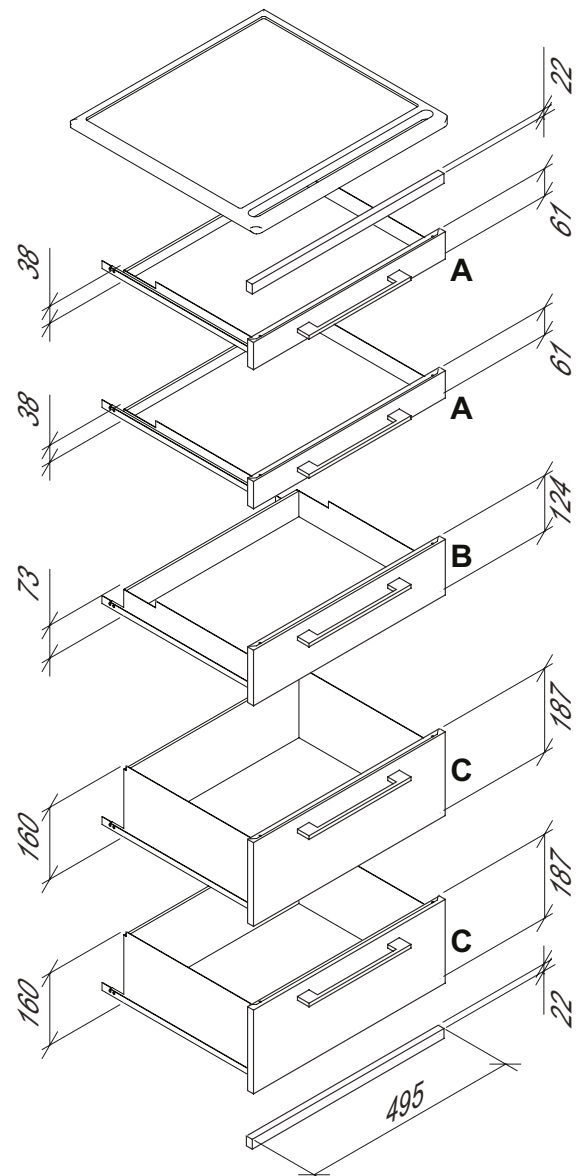
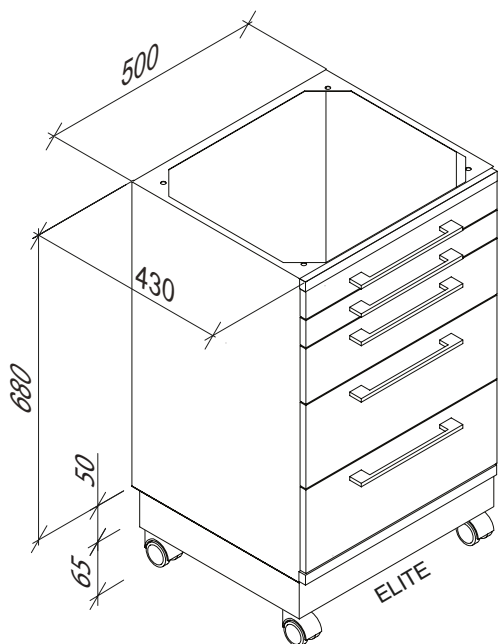
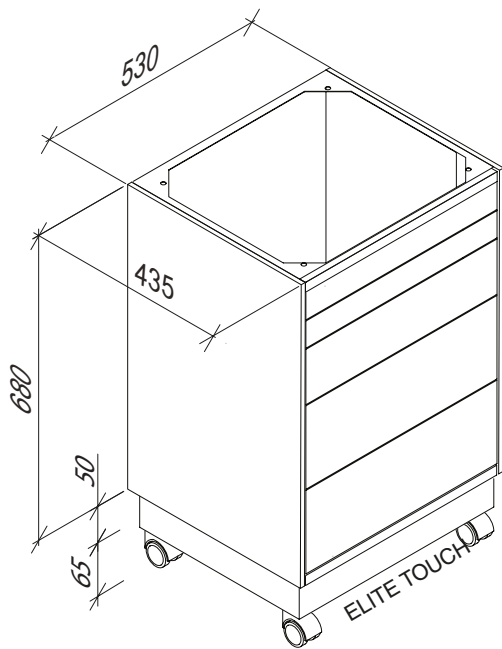

N.B.: Il prezzo è comprensivo di piano - Mobili dotati di guide con rientro automatico

N.B.: The price includes the worktop - Elements with self-closing system of drawers

N.B.: Dans le prix est inclus le plan - Eléments avec système automatique de glissières

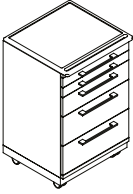
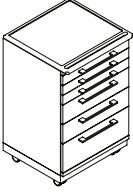
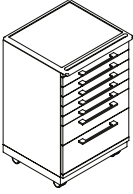
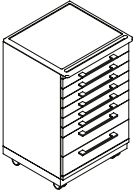
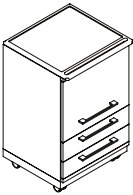
|  |   | Euro                           |                         |                            |
|--|---|--------------------------------|-------------------------|----------------------------|
| Articolo<br>Article  |   | ceramica<br>ceramica<br>resine | vetro<br>glass<br>verre | corian<br>corian<br>corian |
|    | <p><b>Elemento 2 cassetti A - 1 B - 2 C</b><br/>           3 bacinelle - 2 fondi PVC<br/>           2 A drawers - 1 B drawer - 2 C drawers unit<br/>           3 trays - 2 PVC bottoms<br/>           Elément 2 tiroirs A - 1 B - 2 C<br/>           3 intérieurs de tiroirs - 2 fonds en PVC</p>   | ERT5                           |                         |                            |
|    | <p><b>Elemento 3 cassetti A - 2 B - 1 C</b><br/>           4 bacinelle - 2 fondi PVC<br/>           3 A drawers - 2 B drawers - 1 C drawer unit<br/>           4 trays - 2 PVC bottoms<br/>           Elément 3 tiroirs A - 2 B - 1 C<br/>           4 intérieurs de tiroirs - 2 fonds en PVC</p>   | ERT6                           |                         |                            |
|   | <p><b>Elemento 5 cassetti A - 1 B - 1 C</b><br/>           4 bacinelle - 3 fondi PVC<br/>           5 A drawers - 1 B drawer - 1 C drawer unit<br/>           4 trays - 3 PVC bottoms<br/>           Elément 5 tiroirs A - 1 B - 1 C<br/>           4 intérieurs de tiroirs - 3 fonds en PVC</p>  | ERT7                           |                         |                            |
|  | <p><b>Elemento 6 cassetti A - 2 B</b><br/>           5 bacinelle - 3 fondi PVC<br/>           6 A drawers - 2 B drawers unit<br/>           5 trays 1 - 3 PVC bottoms<br/>           Elément 6 tiroirs A - 2 B<br/>           5 intérieurs de tiroirs - 3 fonds en PVC</p>  | ERT8                           |                         |                            |
|  | <p><b>Elemento con 2 ripiani estraibili portastrumenti</b><br/>           antina a scomparsa 2 cassetti B<br/>           1 bacinella - 1 fondo in PVC<br/>           Unit with 2 extractables surgical instruments holders<br/>           disappearance door - 2 B drawers<br/>           1 tray - 1 PVC bottom<br/>           Elément avec 2 plans extractibles porte instruments<br/>           porte escamotable 2 tiroirs B<br/>           1 interieur de tiroirs - 1 fond en PVC</p> | ERTEM2                         |                         |                            |

Articolo  
Article

Euro

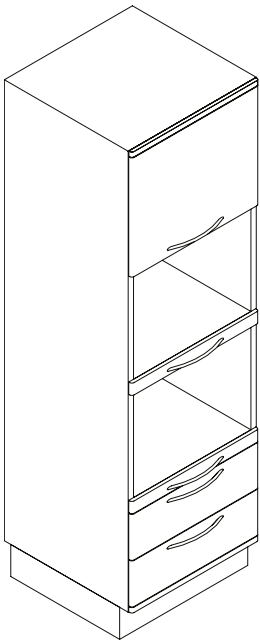
L.60 x P.60 x H.200 **COL/A**

Mobile colonna predisposto per 1 autoclave e sigillatrice + 2 cassetti e 1 anta  
 Tall unit arranged for 1 autoclave and 1 thermo-sealing machine + 2 drawers and 1 door  
 Meuble colonne arrangé pour 1 autoclave et 1 thermosoudeuse + 2 tiroirs et 1 porte

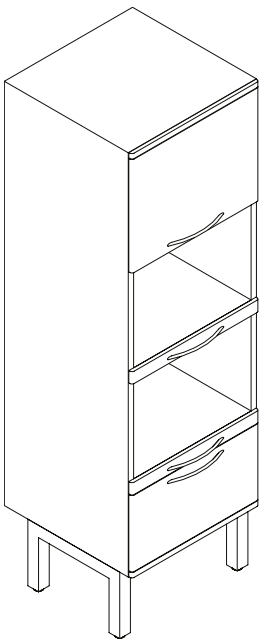
L.60 x P.60 x H.200 **COL/P**

Mobile colonna predisposto per 1 autoclave e 1 sigillatrice +2 ante.  
 Tall unit with 2 doors arranged for 1 autoclave and 1 thermo-sealing machine  
 Meuble colonne avec 2 portes arrangé pour 1 autoclave et 1 thermosoudeuse

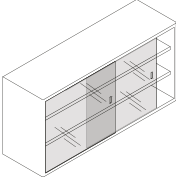
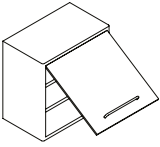
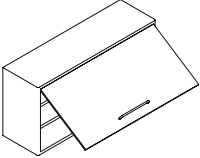
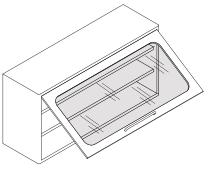
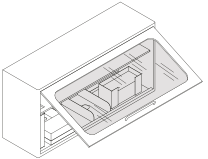
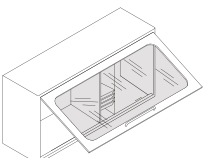
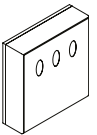
|   |   |                             | Articolo<br>Article | Euro |
|---|---|-----------------------------|---------------------|------|
|    | <b>Pensile a vetri scorrevoli</b><br>2 ripiani in cristallo<br>Wall - unit with sliding plate - glass and 2 shelves<br>Elément mural avec portes en verre coulissantes<br>2 rayons internes   | <i>L.100 x P.30 x H.50</i>  | <b>MV</b>           |      |
|    | <b>Pensile per sterilizzazione</b><br>Sterilizing wall - unit<br>Elément mural pour stérilisation   | <i>L.50 x P.30 x H.50</i>   | <b>ST5</b>          |      |
|   | <b>Pensile per sterilizzazione</b><br>Sterilizing wall - unit<br>Elément mural pour stérilisation   | <i>L.100 x P.30 x H.50</i>  | <b>ST4</b>          |      |
|  | <b>Pensile per sterilizzazione</b><br>completo di lampada ultravioletti<br>Sterilizing wall - unit with uv lamp<br>Elément mural pour stérilisation avec ultra - violet   | <i>L.100 x P.30 x H.50</i>  | <b>ST4/UV</b>       |      |
|  | <b>Pensile per dispenser di prodotti monouso</b><br>Wall unit for disposables<br>Distributeur mural pour produits jetables  | <i>L.100 x P.30 x H.50</i>  | <b>PDM</b>          |      |
|  | <b>Pensile per tray-zirc</b><br>Wall unit for tray-zirc<br>Distributeur mural pour tray-zirc  | <i>L.100 x P.30 x H.50</i>  | <b>PDMZIRC</b>      |      |
|  | <b>Gruppo igiene con dispenser di salviette, guanti, bicchieri e mascherine e distributore di sapone automatico.</b><br>Hanging unit equipped with automatic soap, napkins gloves, mask and glass distributors<br>Groupe hygiène équipé de distributeurs de savon automatique, serviettes, gants, gobelets et distributeur de savon | <i>L.53 x P.13.5 x H.53</i> | <b>PDMP</b>         |      |

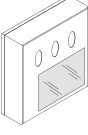
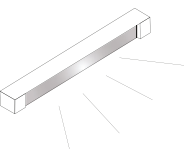
|  |   | Articolo<br>Article                   | Euro                 |
|--|---|---------------------------------------|----------------------|
|   | <p><b>Gruppo igiene</b> con dispenser di salviette, guanti, bicchieri e mascherine.<br/>Hanging unit equipped with napkins, gloves, mask and glass distributors<br/>Groupe hygiène équipé de distributeurs de serviettes, gants, masques et gobelets</p>  | L.53 x P.13.5 x H.53<br><b>PDMDP2</b> |                      |
|   | <p><b>Gruppo igiene</b> con dispenser di salviette, guanti, bicchieri, mascherine, distributore di sapone automatico e specchio.<br/>Hanging unit equipped with automatic soap, napkins, gloves, mask, glass distributors and mirror.<br/>Groupe hygiène équipé de distributeurs de savon automatique, serviettes, gants, masques, gobelets et miroir</p> | L.53 x P.13.5 x H.53<br><b>PDMP5</b>  |                      |
|  | <p><b>Impianto di illuminazione</b><br/>da applicare sotto il pensile<br/>Lighting system under the wall - unit<br/>Installation de illumination pour mettre sous le élément mural</p>  | <b>ILL</b>                            | 50 cm.<br><br>100 cm |

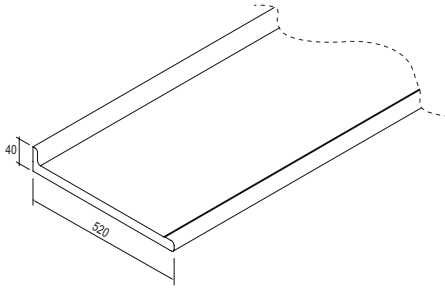

Piano laminato sp. 30 mm con alzatina incorporata  
 H. 40 mm - profondità 520 mm  
 Laminate work top dp. 30 mm with integrated backsplash h. 40 mm  
 - dept 520 mm  
 Plan en laminé ép. 30 mm avec dossieret postformé h. 40 mm  
 - profondeur 520 mm

Euro

PB52

Piano in laminato con alzatina incorporata, al metro  
 Laminate worktop, with integrated backsplash, per meter  
 Plan en laminé avec dossieret postformé, au metre

Piano da 505 x 520 mm con alzatina incorporata  
 Laminate worktop 505 x 520 mm, with integrated backsplash  
 Plan en laminé 505 x 520 mm avec dossieret postformé

Piano da 1005 x 520 mm con alzatina incorporata  
 Laminate worktop 1005 x 520 mm, with integrated backsplash  
 Plan en laminé 1005 x 520 mm avec dossieret postformé

Piano da 1505 x 520 mm con alzatina incorporata  
 Laminate worktop 1505 x 520 mm, with integrated backsplash  
 Plan en laminé 1505 x 520 mm avec dossieret postformé

Piano da 2005 x 520 mm con alzatina incorporata  
 Laminate worktop 2005 x 520 mm, with integrated backsplash  
 Plan en laminé 2005 x 520 mm avec dossieret postformé

Piano da 2505 x 520 mm con alzatina incorporata  
 Laminate worktop 2505 x 520 mm, with integrated backsplash  
 Plan en laminé 2505 x 520 mm avec dossieret postformé

Piano da 3005 x 520 mm con alzatina incorporata  
 Laminate worktop 3005 x 520 mm, with integrated backsplash  
 Plan en laminé 3005 x 520 mm avec dossieret postformé

Piano da 3505 x 520 mm con alzatina incorporata  
 Laminate worktop 3505 x 520 mm, with integrated backsplash  
 Plan en laminé 3505 x 520 mm avec dossieret postformé

Piano angolare con alzatina incorporata da 720 x 720 mm  
 Corner worktop with integrated backsplash, 720 x 720 mm  
 Plan angulaire avec dossieret postformé, 720 x 720 mm

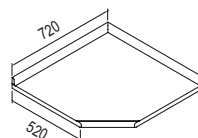

PAB52



Euro

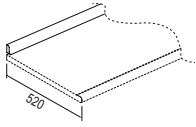

**Piano laminato profondità 520 mm con alzatina applicata**  
- costo al metro

Laminate worktop with sticked backsplash dp. 520 mm, per meter  
Plan en laminé avec dossierer pr. 520 mm, au mètre linéaire

PL52

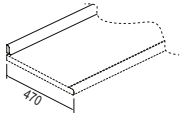

**Piano laminato profondità 470 mm con alzatina applicata**  
- costo al metro

Laminate worktop with sticked backsplash dp. 470 mm, per meter  
Plan en laminé avec dossierer pr. 470 mm, au mètre linéaire

PL47

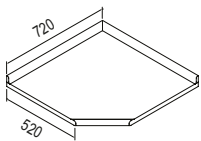

**Piano angolare in laminato con alzatina applicata**

Corner laminate worktop with sticked backsplash  
Plan angulaire en laminé avec dossierer appliqué

L. 52 x 52

PA52

L. 47 x 47

PA47

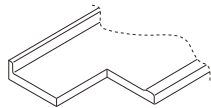

**Taglio speciale su piano laminato**

Special cut of laminate worktop  
Découpe special sur le plan en laminé

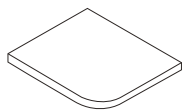

**Arrotondamento su piano laminato**

Corner rounding for laminate worktop  
Angle arrondi pour le plan en laminé

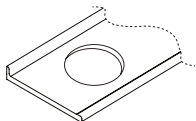

**Foro ø 150/200 su piano laminato**

Waste hole ø 150/200 for laminate worktop  
Trou pour plan en laminé ø 150/200 mm

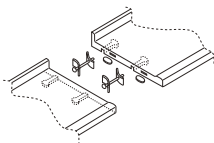

**Set di collegamento fra piani laminati**

Laminate worktop connection set  
Set pour la liaison des plans en laminé

TOP

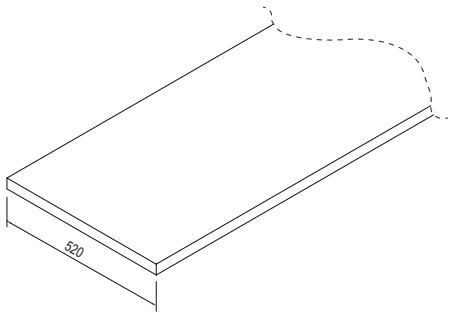

Piano stratificato sp. 12 mm profondità 520 mm  
 Stratified work top dp. 12 mm - dept 520 mm  
 Plan en stratifié ép. 12 mm - profondeur 520 mm

Euro

PSTR

**Piano in stratificato senza alzatina al metro**

Stratified worktop **without backsplash**, dp. 12 mm, per meter  
 Plan en stratifié **sans dossier** ép. 12 mm, au mètre

**Piano da 505 x 520 mm senza alzatina**

Stratified worktop 505 x 520 mm without backsplash  
 Plan en stratifié 505 x 520 mm sans dossier

**Piano da 1005 x 520 mm senza alzatina**

Stratified worktop 1005 x 520 mm without backsplash  
 Plan en stratifié 1005 x 520 mm sans dossier

**Piano da 1505 x 520 mm senza alzatina**

Stratified worktop 1505 x 520 mm without backsplash  
 Plan en stratifié 1505 x 520 mm sans dossier

**Piano da 2005 x 520 mm senza alzatina**

stratified worktop 2005 x 520 mm without backsplash  
 Plan en stratifié 2005 x 520 mm sans dossier

**Piano da 2505 x 520 mm senza alzatina**

Stratified worktop 2505 x 520 mm without backsplash  
 Plan en stratifié 2505 x 520 mm sans dossier

**Piano da 3005 x 520 mm senza alzatina**

Stratified worktop 3005 x 520 mm without backsplash  
 Plan en stratifié 3005 x 520 mm sans dossier

**Piano da 3505 x 520 mm senza alzatina**

Stratified worktop 3505 x 520 mm without backsplash  
 Plan en stratifié 3505 x 520 mm sans dossier

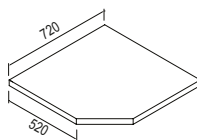

L.47 x 47

L. 52 x 52

**Piano angolare in stratificato senza alzatina**

Corner stratified worktop without backsplash  
 Plan angulaire en stratifié sans dossier

Euro

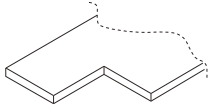

**Taglio speciale su piano stratificato**  
Special cut of stratified worktop  
Découpe special sur le plan en stratifié

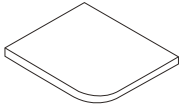

**Arrotondamento su piano stratificato**  
Corner rounding for stratified worktop  
Angle arrondi pour le plan en stratifié

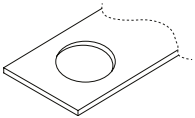

**Foro ø 150/200 su piano stratificato**  
Waste hole ø 150/200 for stratified worktop  
Trou pour plan en stratifié ø 150/200 mm

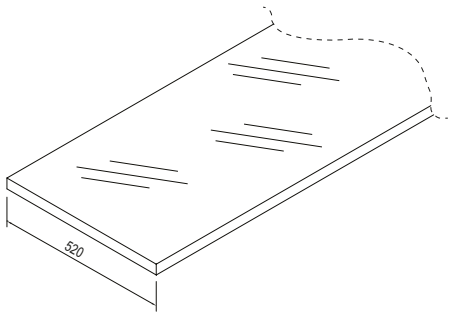

Piano in vetro sp. 15 mm profondità 520 mm  
 Glass worktop th. 15 mm - dept 520 mm  
 Plan en verre ep. 15 mm - profondeur 520 mm

Euro

**Piano in vetro senza alzatina - prezzo al metro (massimo 3 metri)**

Glass worktop **without backsplash** - price per meter (maximum 3 m)  
 Plan en verre **sans dosseret** - prix au mètre (maximum 3 m)

**Piano in vetro senza alzatina con vasca in vetro integrata da 1005 x 520 mm**

Glass worktop without backsplash, with glass sink 1005 x 520 mm  
 Plan en verre sans dosseret avec vasque en verre 1005 x 520 mm

**Piano in vetro senza alzatina con vasca in vetro integrata da 1505 x 520 mm**

Glass worktop without backsplash, with glass sink 1505 x 520 mm  
 Plan en verre sans dosseret avec vasque en verre 1505 x 520 mm

**Piano in vetro senza alzatina con vasca in vetro integrata da 2005 x 520 mm**

Glass worktop without backsplash, with glass sink 2005 x 520 mm  
 Plan en verre sans dosseret avec vasque en verre 2005 x 520 mm

**Piano in vetro senza alzatina con vasca in vetro integrata da 2505 x 520 mm**

Glass worktop without backsplash, with glass sink 2505 x 520 mm  
 Plan en verre sans dosseret avec vasque en verre 2505 x 520 mm

**Piano in vetro angolare senza alzatina con vasca in vetro integrata da 720 x 720 mm**

Corner glass top without backsplash, with corner sink 720 x 720 mm  
 Plan en verre angulaire sans dosseret avec vasque en verre 720 x 720 mm

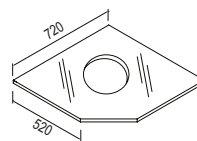

Euro

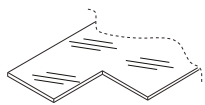
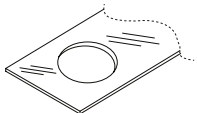
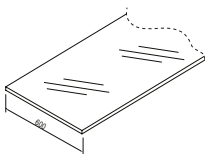
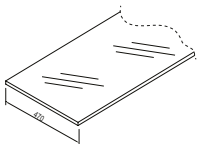
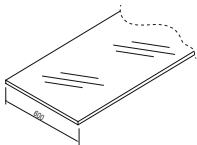
**Taglio personalizzato del piano**Special cut for glass worktop  
Découpe spéciale pur plan en verre**Fori ø 150/200 mm su piani in vetro**Hole for glass worktop, ø 150/200 mm  
Trou sur le plan en verre, ø 150/200 mm**Supplemento al metro lineare per profondità del piano 520 - 560 mm**Additional charge for glass worktop per meter dp. 520 - 560 mm  
Supplément pour plan en verre pour mètre lineaire pr. 520 - 560 mm**Piano profondità 470 mm. - al metro (massimo 3 m)**Glass work top dp. 470 mm - per meter (maximum 3 m)  
Plan en verre pr. 470 mm - au mètre (maximum 3 m)**Piano in vetro profondità 600 mm - prezzo al metro (massimo 3 m)**Glass worktop dp. 600 mm, per meter (maximum 3 m)  
Plan en verre pr. 600 mm, au mètre (maximum 3 m)

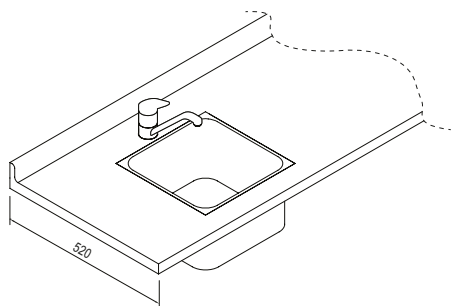

Piano in acciaio inox con lavello e miscelatore,  
 profondità piano 520 mm  
 Stainless steel worktop with sink and tap mixer - depth 520 mm  
 Plan en acier inox avec lavabo et mélangeur - profondeur 520 mm

Euro

**Piano acciaio inox da 1505 x 520 con lavello e miscelatore.**

Stainless steel worktop with sink and tap mixer - 1505 x 520 mm  
 Plan en acier inox avec lavabo et mélangeur - 1505 x 520 mm

PILX1

**Piano acciaio inox da 2005 x 520 con lavello e miscelatore.**

Stainless steel worktop with sink and tap mixer - 2005 x 520 mm  
 Plan en acier inox avec lavabo et mélangeur - 2005 x 520 mm

PILX2

**Piano acciaio inox da 2505 x 520 con lavello e miscelatore.**

Stainless steel worktop with sink and tap mixer - 2505 x 520 mm  
 Plan en acier inox avec lavabo et mélangeur - 2505 x 520 mm

PILX3

**Piano acciaio inox angolare da 720 x 720 con lavello e miscelatore.**

corner stainless steel worktop with sink and tap mixer 720 x 720 mm  
 Plan en acier inox avec lavabo et mélangeur 720 x 720 mm

PILX4

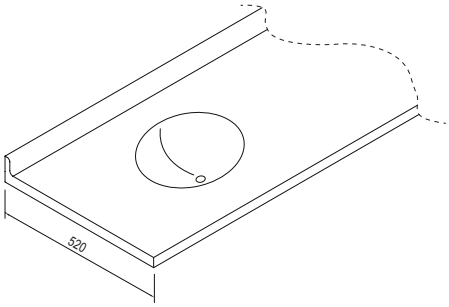

Piano in corian sp. 12 mm profondità 520 mm con vasca integrata - alzatina raccordata  
 Corian worktop with corian sink th. 12 mm, depth 520 mm with integrated backsplash  
 Plan en corian avec vasque en corian sp. 12 mm, profondeur 520 mm avec dossieret postformé

Euro

Piano in corian **senza alzatina**, prezzo al metro lineare

Corian worktop **without backsplash**, price per meter  
 Plan en corian **sans dossieret**, prix au mètre

Piano in corian con vasca in corian integrata e alzatina raccordata da 1505 x 520

Corian worktop with corian sink and integrated backsplash - 1505 x 520 mm  
 Plan en corian avec vasque en corian et dossieret postformé - 1505 x 520 mm

Vasca rotonda  
 Round sink  
 Vasque arrondie

Vasca quadrata  
 Rectangular sink  
 Vasque carrée

Piano in corian con vasca in corian integrata e alzatina raccordata da 2005 x 520

Corian worktop with corian sink and integrated backsplash - 2005 x 520 mm  
 Plan en corian avec vasque en corian et dossieret postformé - 2005 x 520 mm

Vasca rotonda  
 Round sink  
 Vasque arrondie

Vasca quadrata  
 Rectangular sink  
 Vasque carrée

Piano in corian con vasca in corian integrata e alzatina raccordata da 2505 x 520

Corian worktop with corian sink and integrated backsplash - 2505 x 520 mm  
 Plan en corian avec vasque en corian et dossieret postformé - 2505 x 520 mm

Vasca rotonda  
 Round sink  
 Vasque arrondie

Vasca quadrata  
 Rectangular sink  
 Vasque carrée

Piano angolare in corian con vasca in corian integrata da 720 x 720 mm

Corner corian worktop with corian sink and integrated backsplash - 720 x 720 mm  
 Plan en corian angoulaire avec vasque en corian et dossieret postformé - 720 x 720 mm

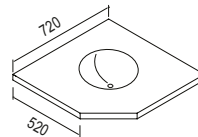

Vasca rotonda  
 Round sink  
 Vasque arrondie

Vasca quadrata  
 Rectangular sink  
 Vasque carrée

Euro

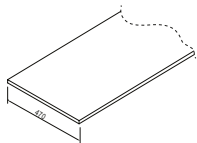

**Piano in corian senza alzatina, profondità 470 mm, prezzo al metro**

Corian worktop without backsplash, depth 470 mm, price per meter  
Plan en corian sans dosseret, profondeur 470 mm, prix au mètre

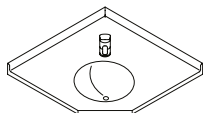

**Piano angolare in corian con vasca corian integrata e alzatina  
raccordata da 670 x 670 mm**

Corner corian worktop with corian sink and integrated backsplash, 670 x 670 mm  
Plan angulaire en angle avec vasque en corian et dosseret post formé, 670 x 670 mm

Vasca rotonda  
Round sink  
Vasque arrondie

Vasca quadrata  
Rectangular sink  
Vasque carrée

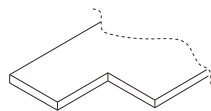

**Taglio speciale su piano in corian**

Special cut of corian worktop  
Découpe special sur le plan en corian

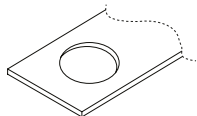

**Foro ø 150/200 personalizzato su piano in corian**

Waste hole ø 150/200 for corian worktop  
Trou pour plan en corian ø 150/200 mm

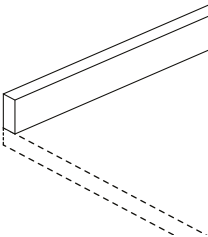
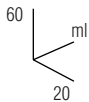
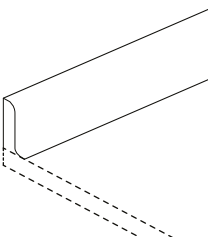
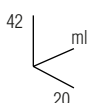
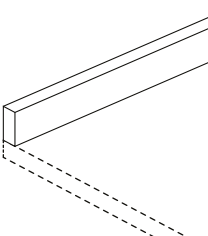
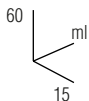
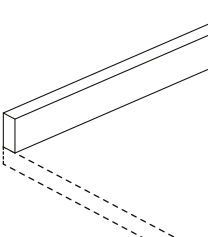
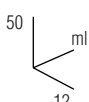
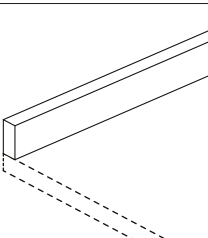
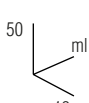
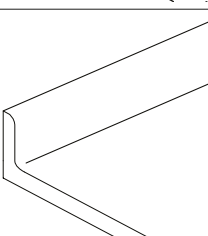
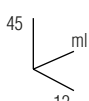
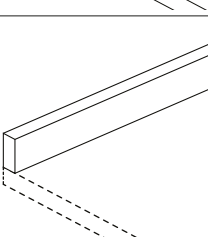
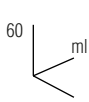

|   |   | Articolo<br>Article  | Euro/ml      |
|---|---|--|--------------|
|    | <b>Alzatina in acciaio al metro</b><br>Stainless steel backsplash per meter<br>Dossieret en inox au mètre   |  60<br>ml<br>20   | <b>ALAC</b>  |
|    | <b>Alzatina in alluminio, al metro</b><br>Aluminium backsplash, per meter<br>Dossieret au aluminium, au mètre                                       |  42<br>ml<br>20   | <b>ALAL</b>  |
|   | <b>Alzatina in vetro, al metro (massimo 3 metri)</b><br>Glass backsplash, per meter (max 3 meters)<br>Dossieret en verre, au mètre (max 3 mètres)   |  60<br>ml<br>15  | <b>ALVE</b>  |
|  | <b>Alzatina in corian da siliconare, al metro</b><br>Corian backsplash to be sticked, per meter<br>Dossieret en corian pour être appliqué, au mètre |  50<br>ml<br>12 | <b>ALCO1</b> |
|  | <b>Alzatina in corian applicata a 90°, al metro</b><br>Sticked 90° corian backsplash, per meter<br>Dossieret appliqué 90°, au mètre                 |  50<br>ml<br>12 | <b>ALCO2</b> |
|  | <b>Alzatina in corian raccordata, al metro</b><br>Corian connected backsplash, per meter<br>Dossieret raccordé en corian, au mètre                  |  45<br>ml<br>12 | <b>ALCO3</b> |
|  | <b>Alzatina in stratificato, al metro</b><br>Stratified backsplash, per meter<br>Dossieret en stratifié, au mètre                                   |  60<br>ml<br>12 | <b>ALST</b>  |

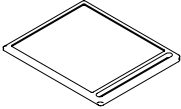
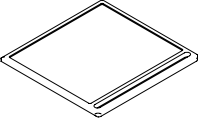
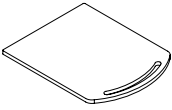
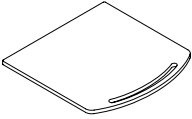
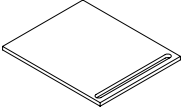
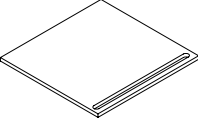
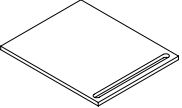
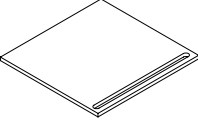
|   |   |      | Articolo<br>Article | Euro |
|---|---|------|---------------------|------|
|    | <b>Piano in ceramica con maniglia per servomobile</b><br>Ceramic top with handle for mobile element<br>Plan en résiné avec poignée pour élément sur roulettes           | L.40 | <b>AC40</b>         |      |
|     | <b>Piano in ceramica con maniglia per servomobile</b><br>Ceramic top with handle for mobile element<br>Plan en résiné avec poignée pour élément sur roulettes           | L.50 | <b>AC50</b>         |      |
|    | <b>Piano in vetro con maniglia per servomobile</b><br>Glass top with handle for mobile element<br>Plan en verre avec poignée pour élément sur roulettes                 | L.40 | <b>AVE40</b>        |      |
|     | <b>Piano in vetro con maniglia per servomobile</b><br>Glass top with handle for mobile element<br>Plan en verre avec poignée pour élément sur roulettes                 | L.50 | <b>AVE50</b>        |      |
|  | <b>Piano in corian con maniglia per servomobile</b><br>Corian top with handle for mobile element<br>Plan en corian avec poignée pour élément sur roulettes              | L.40 | <b>ACO40</b>        |      |
|   | <b>Piano in corian con maniglia per servomobile</b><br>Corian top with handle for mobile element<br>Plan en corian avec poignée pour élément sur roulettes              | L.50 | <b>ACO50</b>        |      |
|   | <b>Piano in stratificato con maniglia per servomobile</b><br>Stratified top with handle for mobile element<br>Plan en stratifié avec poignée pour élément sur roulettes | L.40 | <b>ASTR40</b>       |      |
|   | <b>Piano in stratificato con maniglia per servomobile</b><br>Stratified top with handle for mobile element<br>Plan en stratifié avec poignée pour élément sur roulettes | L.50 | <b>ASTR50</b>       |      |

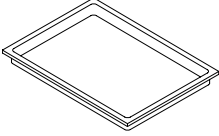
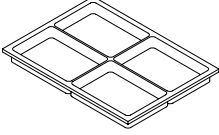
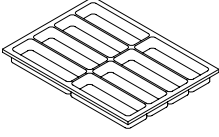
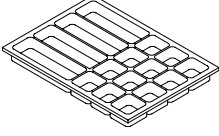
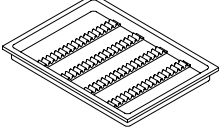
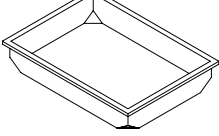
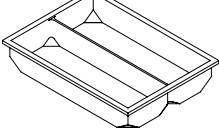
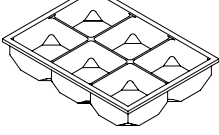
|  |  |                     | Articolo<br>Article | Euro |
|--|--|---------------------|---------------------|------|
|    | <b>Bacinella 1 settore per cassetto piccolo</b><br>1 sector basin for small drawer<br>Intérieur 1 secteur pour petit tiroir          | L.45 x P.32 x H.3.7 | <b>BA-A01</b>       |      |
|    | <b>Bacinella 4 settori per cassetto piccolo</b><br>Basin 4 sectors for small drawer<br>Intérieur à 4 secteurs pour petit tiroir      | L.45 x P.32 x H.3.7 | <b>BA-A04</b>       |      |
|    | <b>Bacinella 8 settori per cassetto piccolo</b><br>Basin 8 sectors for small drawer<br>Intérieur à 8 secteurs pour petit tiroir      | L.45 x P.32 x H.3.7 | <b>BA-A08</b>       |      |
|   | <b>Bacinella 16 settori per cassetto piccolo</b><br>Basin 16 sectors for small drawer<br>Intérieur à 16 secteurs pour petit tiroir   | L.45 x P.32 x H.3.7 | <b>BA-A16</b>       |      |
|  | <b>Bacinella a rastrelliera per cassetto piccolo</b><br>Rack low basin for small drawer<br>Intérieur avec ratelier pour petit tiroir | L.45 x P.32 x H.3.7 | <b>BA-A36</b>       |      |
|  | <b>Bacinella 1 settore per cassetto medio</b><br>1 sector hight basin for medium drawer<br>Intérieur à 1 secteur pour tiroir moyen   | L.45 x P.32 x H.8   | <b>BA-B01</b>       |      |
|  | <b>Bacinella 2 settori per cassetto medio</b><br>2 sectors hight basin for medium drawer<br>Intérieur à 2 secteurs pour tiroir moyen | L.45 x P.32 x H.8   | <b>BA-B02</b>       |      |
|  | <b>Bacinella 6 settori per cassetto medio</b><br>6 sectors hight basin for medium drawer<br>Intérieur à 6 secteurs pour tiroir moyen | L.45 x P.32 x H.8   | <b>BA-B06</b>       |      |

N.B.: Per modelli ST e SR

N.B.: For ST and SR models

N.B.: Pour model ST et SR

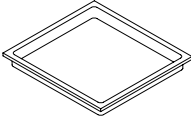
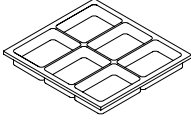
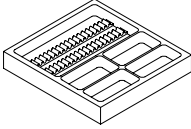
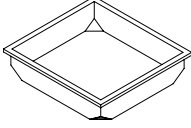
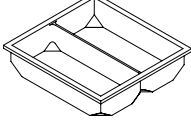
|  |   | Articolo<br>Article                                     | Euro |
|--|---|---|------|
|    | <b>Bacinella 1 settore per cassetto piccolo</b><br>1 sector basin for small drawer<br>intérieur 1 secteur pour petit tiroir             | <i>L.35.2 x P.32.7<br/>x H.3.7</i><br><b>BA-AS01</b>    |      |
|    | <b>Bacinella small a 6 settori per cassetto piccolo</b><br>6 sectors basin for small drawer<br>Intérieur à 6 secteurs pour petit tiroir | <i>L.35.2 x P.32.7<br/>x H.3.7</i><br><b>BA-AS06</b>    |      |
|    | <b>Bacinella small rastrelliera per cassetto piccolo</b><br>Basin for small drawer<br>Intérieur pour petit tiroir                       | <i>L.35.2 x P.32.7<br/>x H.3.7</i><br><b>BA-ASRASTR</b> |      |
|    | <b>Bacinella 1 settore per cassetto medio</b><br>1 sector basin for medium drawer<br>intérieur 1 secteur pour tiroir moyen              | <i>L.35.2 x P.32.7<br/>x H.7.8</i><br><b>BA-BS01</b>    |      |
|  | <b>Bacinella small 2 settori per cassetto medio</b><br>2 sectors basin for medium drawer<br>Intérieur à 2 secteurs pour medium tiroir   | <i>L.35.2 x P.32.7<br/>x H.7.8</i><br><b>BA-BS02</b>    |      |

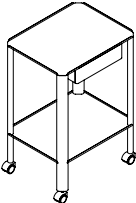
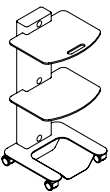
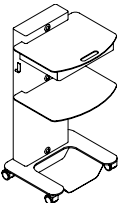
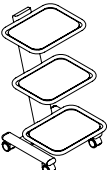
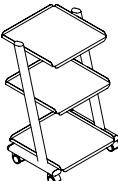
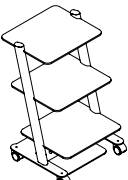
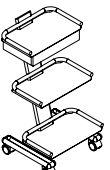

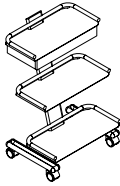
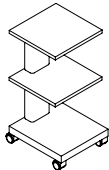
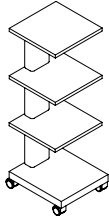
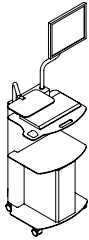
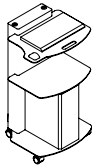

|   | Articolo<br>Article                          | Euro |
|---|--|------|
|  <p><b>Carrello 2 ripiani e cassetto</b><br/>Trolley with 2 shelves and drawer<br/>Chariot avec 2 plans et 1 tiroir</p>   | <p>L.55 x P.43 x H.82      <b>C2R</b></p>    |      |
|  <p><b>Carrello chirurgico piccolo 2 ripiani vetro</b><br/>3 prese di corrente<br/>Small surgical trolley with 2 glass shelves and 3 current taps<br/>Chariot chirurgie petit avec 2 étagères en verre<br/>3 prises de courant</p>                                | <p>L.42 x P.34 x H.88      <b>C2RCHP</b></p> |      |
|  <p><b>Carrello chirurgico grande</b><br/>2 ripiani vetro - 1 cassetto e 3 prese di corrente<br/>Maxi surgical trolley<br/>2 glass shelves - 1 drawer an 3 current taps<br/>Chariot chirurgie maxi<br/>2 étagères en verre - 1 tiroir et 3 prises de courant</p> | <p>L.48 x P.38 x H.92      <b>C2RCHM</b></p> |      |
|  <p><b>Carrello 3 ripiani con 2 prese universali</b><br/>Trolley with 3 shelves and 2 current taps<br/>Chariot 3 plateaux et 2 prises normalisées</p>   | <p>L.40 x P.45 x H.79      <b>C3R</b></p>    |      |
|  <p><b>Carrello 3 ripiani con 3 prese universali</b><br/>Trolley with 3 shelves and 3 current taps<br/>Chariot 3 plateaux et 3 prises de courant</p>  | <p>L.48 x P.40 x H.79      <b>C3RK</b></p>   |      |
|  <p><b>Carrello 3 ripiani in vetro con 2 prese universali</b><br/>Trolley with 3 glass shelves and 2 current taps<br/>Chariot 3 plateaux en verre et 2 prises normalisées</p>   | <p>L.49 x P.37 x H.79.5      <b>C3RV</b></p> |      |
|  <p><b>Carrello portastrumenti 3 ripiani</b><br/>1 cassetto con 2 prese universali<br/>Instruments holder trolley with 3 shelves<br/>1 drawer and 2 current taps<br/>Chariot porte instruments 3 étagères<br/>1 tiroir et 2 prises de courant</p>               | <p>L.40 x P.54 x H.93      <b>C3RT</b></p>   |      |

|   |   |                      | Articolo<br>Article | Euro |
|---|---|----------------------|---------------------|------|
|    | <p><b>Carrello portastrumenti 3 ripiani</b><br/>                     1 cassetto con 2 prese universali<br/>                     Instruments holder trolley with 3 shelves<br/>                     1 drawer and 2 current taps<br/>                     Chariot porte instruments 3 étagères<br/>                     1 tiroir et 2 prises de courant</p> | L.50 x P.54 x H.93   | <b>C3RTM</b>        |      |
|    | <p><b>Carrello portastrumenti 3 ripiani</b><br/>                     con 2 prese universali<br/>                     Instruments holder trolley with 3 shelves<br/>                     2 current taps<br/>                     Chariot porte instruments 3 étagères<br/>                     2 prises de courant</p>                                     | L.35 x P.45 x H.78   | <b>C3RQ</b>         |      |
|   | <p><b>Carrello 4 ripiani e 3 prese di corrente</b><br/>                     Trolley with 4 shelves and 3 current taps<br/>                     Chariot avec 4 étagères et 3 prises de courant</p>   | L.35 x P.45 x H.98.5 | <b>C4RQ</b>         |      |
|  | <p><b>Carrello elettrificato porta PC/telecamera/monitor</b><br/>                     con ripiani in vetro<br/>                     Electrified PC holder trolley with glass shelves<br/>                     chariot électrifié porte PC avec étagères en verre</p>  | L.56 x P.50 x H.150  | <b>CPCV</b>         |      |
|  | <p><b>Carrello elettrificato porta PC/senza bracci</b><br/>                     con ripiani in vetro<br/>                     Electrified PC holder trolley without arms with glass shelves<br/>                     chariot électrifié porte PC sans bras avec étagères en verre</p>   | L.56 x P.50 x H.94   | <b>CPCVSB</b>       |      |

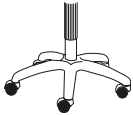
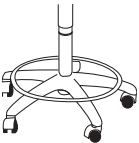

|   |  | Articolo<br>Article | Euro |
|---|--|---------------------|------|
|  | <p><b>Sedia girevole in faggio mod. Avant-Garde</b><br/>                     base a 5 razze in ABS nera con ruote<br/>                     Beechwood swivel chair Avant-Garde model<br/>                     5-spoke base made of black ABS with wheels<br/>                     Siège pivotant en hêtre modèle Avant-Garde<br/>                     base avec 5 bras réalisé en ABS noir avec roues</p> | <b>FGA</b>          |      |

**SEGGIOLINO DA STUDIO                      STOOLS FOR DENTAL SURGERY                      SIEGES OPERATEURS AVEC VERIN A GAZ**

|   |   | Articolo<br>Article                    | Euro |
|---|---|--|------|
|  | <p><b>Seggiolino mod. Classic</b><br/>                     con sedile girevole e regolabile in altezza (da cm. 50 a max cm. 65) - Comando alzata manuale<br/>                     Classic model stool<br/>                     with circular shaped swivel seat. Height can be regulated (from 50 to max. 65 cm.) - Manual-operated raising control<br/>                     Siège modèle Classic<br/>                     avec assise circulaire pivotante et réglable en hauteur (de cm. 50 à cm. 65 max) - Commande d'élévation à main</p>   | <i>L.55 x P.55 x H.90</i><br><b>CL</b> |      |
|  | <p><b>Seggiolino mod. Future</b><br/>                     con sedile girevole regolabile in altezza (da cm. 45 a max cm. 60) - Comando a pedale. Schienale regolabile girevole indipendente dal sedile<br/>                     Future model stool with circular shaped swivel seat. Height can be regulated (from 45 to max. 60 cm.) - Foot-operated raising control. Adjustable swivel back, independent of the chair<br/>                     Siège modèle Future avec assise circulaire pivotante et réglable en hauteur (de cm. 45 à cm. 60 max) - Commande d'élévation à pied. Réglage du dossier pivotant indépendant du siège</p> | <i>L.55 x P.55 x H.90</i><br><b>FU</b> |      |

|   |  | Articolo<br>Article         | Euro |
|---|--|-----------------------------|------|
|    |  | $\varnothing 34 \times H.6$ |      |
|   | <b>Seduta e schienale con imbottitura sottile</b><br>Thin padded seat and back<br>Assise et dossier avec rembourrage mince                               |                             |      |
|    |  | $\varnothing 34 \times H.8$ |      |
|   | <b>Seduta e schienale con imbottitura spessa</b><br>Thick padded seat and back<br>Assise et dossier avec rembourrage épais                               |                             |      |
|     |  |                             |      |
|   | <b>Base a 5 razze in ABS - colore: grigio o nero</b><br>5-spoke base made ABS - colour: grey or black<br>Base avec 5 bras en ABS - couleur: gris ou noir |                             |      |
|   |  |                             |      |
|   | <b>Poggiapiedi in acciaio per base ABS</b><br>Steel footrest for ABS base<br>Repose-pieds en acier pour base en ABS                                      |                             |      |
|   |  |                             |      |
|   | <b>Base a 5 razze in acciaio</b><br>5-spoke base made of steel<br>Base avec 5 bras en acier  |                             |      |
|  |  |                             |      |
|   | <b>Kit 5 ruote per seggiolino (nere o grigie)</b><br>5 castors kit for chair (black or grey)<br>Kit 5 roulettes pour siège (noir or gris)                |                             |      |

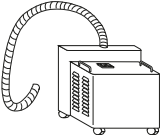
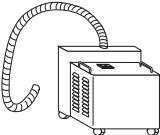

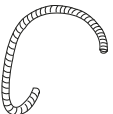
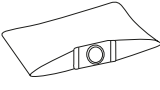
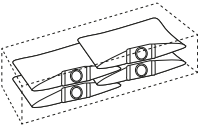
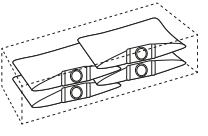
|  |   | Articolo<br>Article                   | Euro |
|--|---|---------------------------------------|------|
|    | <b>Aspirazione portatile per laboratorio e studio</b><br>Portable suction unit for laboratory and studio<br>Aspiration portative pour laboratoire et cabinet  | L.38 x P.27 x H.34<br><b>ZF/ET97</b>  |      |
|    | <b>Aspirazione portatile automatica per laboratorio e studio</b><br>Portable suction unit for laboratory and studio with automatic start<br>Aspiration portative pour laboratoire et cabinet avec partance en automatique | L.38 x P.27 x H.34<br><b>ZF/ET97P</b> |      |
|    | <b>Elemento per aspirazione</b><br>completo di protezione in plexiglas<br>Cuction element complete with plexiglas protection<br>Élément pour aspiration complet de protection en plexiglas                                | L.50 x P.44 x H.79<br><b>CASP</b>     |      |
|  | <b>Tubo per aspirazione</b><br>Suction tube<br>Tuyau pour aspiration  | <b>TUASP</b>                          |      |
|  | <b>Sacchetto filtro per aspirazione</b><br>Suction filtering bag<br>Filtre a manche pour aspiration   | <b>SF</b>                             |      |
|  | <b>Confezione da 4 sacchetti filtro per aspirazione</b><br>Pocket of n° 4 filters for portable suction<br>Boîte de nr. 4 filtres á manche pour aspiration   | <b>SF4</b>                            |      |
|  | <b>Confezione da 10 sacchetti filtro per aspirazione</b><br>Pocket of n° 10 filters for portable suction<br>Boîte de nr. 10 filtres á manche pour aspiration  | <b>SF10</b>                           |      |
|  | <b>Motore per aspirazione</b><br>Motor for portable suction<br>Moteur pour aspiration portative   | <b>MOTASP</b>                         |      |
|  | <b>Filtro protezione motore</b><br>Motor protection filter<br>Filtre de protection du moteur  | <b>FILMOTASP</b>                      |      |

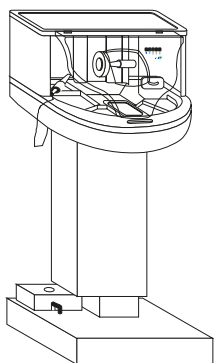

**Elemento mobile**

per la rifinitura di strutture protesiche completo di:

- pulitrice monoalbero a 1400 giri/minuto
- aspirazione silenziosa
- lampada ad alta resa cromatica
- interruttore generale e interruttori per l'accensione dei singoli apparecchi
- protezione in policarbonato
- base autofrenante a sostegno plantare
- alloggiamento per qualsiasi marca di reostato e micromotore
- sacchetto filtro in fibre sintetiche

**PRODOTTO CERTIFICATO CE**

Prosthesis finishing unit equipped:

- 1.400 rpm single-shaft polisher
- noiseless suction unit
- lamp with high chromatic yield
- master switch and switches for single appliances
- polycarbonate protection
- self-braking base to lay feet on
- housing for any make of reostat and micromotor
- filter bag made from synthetic fibres

**EC CERTIFIED**

L.50 x P.48 x H.112

**A BOX**

meuble pour le finissage des structures prothétiques équipé de :

- polisseuse mono-arbre à 1.400 tours-minute
- système d'aspiration silencieux
- lampe à haut rendement chromantique
- interrupteur général et interrupteurs pour allumer chaque appareil
- protection en polycarbonate
- base autofreinante pour l'appui des pieds
- logement pour une marque quelconque de rhéostat et micromoteur
- filtre à sac en fibres synthétiques

**PRODUCT CERTIFIED CE**

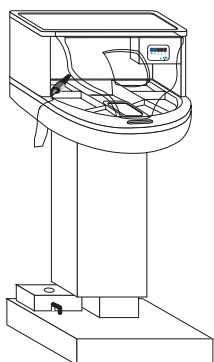

**Elemento mobile**

per la rifinitura di strutture protesiche completo di:

- aspirazione silenziosa
- lampada ad alta resa cromatica
- interruttore generale e interruttori per l'accensione dei singoli apparecchi
- protezione in policarbonato
- base autofrenante a sostegno plantare
- alloggiamento per qualsiasi marca di reostato e micromotore
- sacchetto filtro in fibre sintetiche

**- SENZA PULITRICE**

**PRODOTTO CERTIFICATO CE**

Prosthesis finishing unit equipped:

- noiseless suction unit
- lamp with high chromatic yield
- master switch and switches for single appliances
- polycarbonate protection
- self-braking base to lay feet on
- housing for any make of reostat and micromotor
- filter bag made from synthetic fibres

**- WITHOUT CLEANING MACHINE**

**EC CERTIFIED**

L.50 x P.48 x H.112

**C BOX**

meuble pour le finissage des structures prothétiques équipé de :

- système d'aspiration silencieux
- lampe à haut rendement chromantique
- interrupteur général et interrupteurs pour allumer chaque appareil
- protection en polycarbonate
- base autofreinante pour l'appui des pieds
- logement pour une marque quelconque de rhéostat et micromoteur
- filtre à sac en fibres synthétiques

**- SANS APPAREIL POUR LE NETTOYAGE**

**PRODUIT CERTIFIED CE**

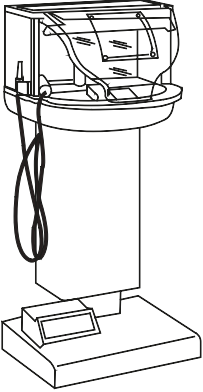
|  |  | Articolo<br>Article | Euro |
|--|--|---------------------|------|
|  | <p><b>Postazione di lavoro</b> da laboratorio per piccoli lavori di sgrossatura e tiratura di gesso, metalli e resina equipaggiato con:</p> <ul style="list-style-type: none"> <li>- aspirazione regolabile (manuale o automatica)</li> <li>- lampada ad alta resa cromatica</li> <li>- caviglia regolabile</li> <li>- interruttore generale, interruttori per l'accensione della luce e dell'aspirazione</li> <li>- protezione in policarbonato per proteggere l'operatore dalle polveri nocive</li> <li>- base autofrenante a sostegno plantare</li> <li>- struttura su ruote per la massima maneggevolezza</li> <li>- sacchetto filtro in fibre sintetiche</li> </ul>   | <b>LAB</b>          |      |
|  | <p>Job's emplacement for laboratory for small jobs of rough shaping and pulling of chalk, metals and resin equipped with:</p> <ul style="list-style-type: none"> <li>- adjustable aspiration (manual or automatic)</li> <li>- lamp to high chromatic yield</li> <li>- adjustable ankle</li> <li>- master switch, switches for the ignition of the light and the aspiration</li> <li>- polycarbonate protection in order to protect the operator from harmful powders</li> <li>- self-braking base to lay feet on</li> <li>- structure on wheels for the maximum ease of handling</li> <li>- filter bag made from synthetic fibres</li> </ul> <p>Poste de travail pour laboratoire destiné aux retouches, grattage, et meulage de plâtre, métaux et résine équipé de :</p> <ul style="list-style-type: none"> <li>- aspiration à variation manuelle ou réglage automatique</li> <li>- lampe à haut rendement chromatique</li> <li>- Cheville ajustable</li> <li>- Interrupteurs pour : "Mise sous tension" - "Eclairage" - "Aspiration".</li> <li>- Protection pour la poussière en polycarbonate</li> <li>- Base repose pieds auto bloquante</li> <li>- Base sur roulettes pour un positionnement dynamique</li> <li>- Sachet de récupération des déchets en fibre synthétique.</li> </ul> |                     |      |





L.50 x P.48 x H.112



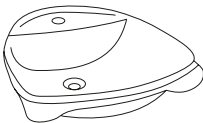
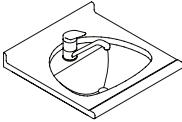
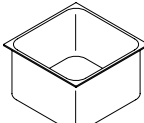
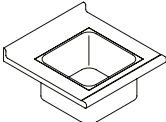
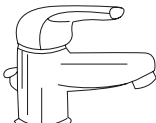
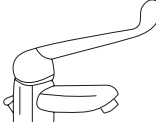

## MICROMOTORE

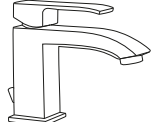

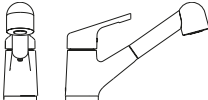
## MICROMOTOR

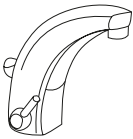
## MICROMOTEUR

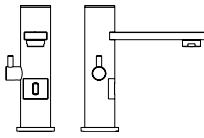
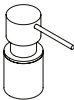
|   |   | Articolo<br>Article | Euro |
|---|---|---------------------|------|
|  | <p><b>Micromotore con alimentatore a pedale (Sirio)</b><br/>Micromotor with foot supply (Sirio)<br/>Micromoteur avec alimentation à pied (Sirio)</p>    | <b>MM</b>           |      |
|  | <p><b>Kit in Plexiglas di protezione per Amico Box</b><br/>Plexiglas protection Kit for Amico Box<br/>Kit en plexiglas de protection pour Amico Box</p> | <b>PA</b>           |      |
|  | <p><b>Sacchetto filtro per Amico Box</b><br/>Filter bag for Amico Box<br/>Sachet filtre pour Amico Box</p>  | <b>SA</b>           |      |

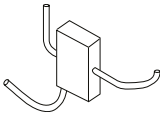
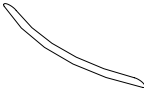
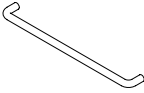
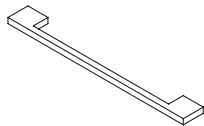
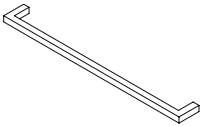
|  |  | Articolo<br>Article | Euro  |
|--|--|---------------------|---|
|    | <b>Vasca in ceramica a filo piano</b><br>Ceramic sink<br>Vasque en ceramique   | <b>VC</b>           |   |
|    | <b>Vasca in ceramica applicata sotto piano</b><br>Ceramic sink applied under the top<br>Vasque en ceramique appliquée sous le plan                   | <b>VCP</b>          |   |
|    | <b>Vasca inox a filo piano</b><br>Stainless steel sink<br>Vasque en inox   | <b>VIX</b>          | Vasca rotonda<br>Round sink<br>Vasque arrondie<br><br>Vasca quadrata<br>Rectangular sink<br>Vasque carrée |
|    | <b>Vasca inox applicata sotto piano</b><br>Stainless steel sink applied under the top<br>Vasque en inox appliquée sous le plan                       | <b>VIXP</b>         | Vasca rotonda<br>Round sink<br>Vasque arrondie<br><br>Vasca quadrata<br>Rectangular sink<br>Vasque carrée |
|  | <b>Miscelatore con leva corta</b><br>Single lever basin mixer<br>Mélangeur   | <b>MLC</b>          |   |
|  | <b>Miscelatore con leva lunga</b><br>Long lever basin mixer<br>Mélangeur avec levier clinique  | <b>MLL</b>          |   |
|  | <b>Monocomando per lavello con leva di comando lunga</b><br>Long -lever single hole sink mixer<br>Mitigreur d'évier monotrou avec levier long        | <b>MCLL</b>         |   |
|  | <b>Miscelatore lavabo</b><br>Wash basin mixer<br>Mélangeur   | <b>ML</b>           |   |
|  | <b>Miscelatore a collo alto</b><br>Single-lever sink mixer, swivel spout<br>Mitigreur d'évier avec bec pivotant                                      | <b>MCA</b>          |   |
|  | <b>Monocomando per lavello con doccetta estraibile</b><br>Single lever sink mixer, with put out shower<br>Mitigreur d'évier avec douchette enlevable | <b>MDE</b>          |   |

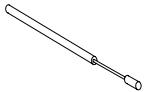
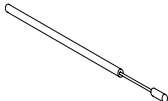
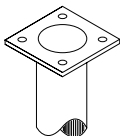
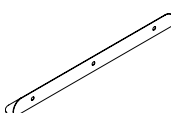
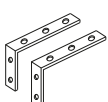
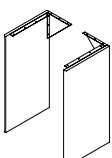
|   |  | Articolo<br>Article | Euro |
|---|--|---------------------|------|
|     | <b>Miscelatore elettronico completo con regolazione temperatura</b><br>Complete electronic mixer with temperature adjustment<br>Robinet infrarouge | <b>MEC1</b>         |      |
|     | <b>Miscelatore elettronico</b><br>Electronic mixer<br>Robinet infrarouge   | <b>MEC2</b>         |      |
|     | <b>Miscelatore elettronico</b><br>Electronic mixer<br>Robinet infrarouge   | <b>MEG</b>          |      |
|     | <b>Distributore di sapone</b><br>Manual soap distributor<br>Distributeur manuel de savon   | <b>DS</b>           |      |
|   | <b>Distributore di sapone per PDMP</b><br>Manual soap distributor for PDMP<br>Distributeur manuel de savon pour PDMP                               |                     |      |
|   | <b>Kit comando elettromagnetico 24V</b><br>24V electro-magnetic control kit<br>Kit de commande eau électromagnétique 24V                           | <b>CE</b>           |      |
|   | <b>Maniglia ad arco</b><br>Arc handle<br>Poignée en arc  | <b>MAR</b>          |      |
|  | <b>Maniglia quadra</b><br>Rectangular handle<br>Poignée carrée   | <b>MQ</b>           |      |
|   | <b>Maniglia rettangolare modello Elite</b><br>Rectangular handle Elite model<br>Poignée carrée Elite   | <b>MARE</b>         |      |
|   | <b>Maniglia rettangolare modello Elite (L. 40 cm)</b><br>Rectangular handle Elite model (L. 40 cm)<br>Poignée carrée Elite (L. 40 cm)              | <b>MARE2</b>        |      |

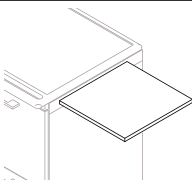
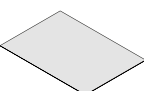
|   |  | Articolo<br>Article | Euro                    |
|---|--|---------------------|-------------------------|
|    | <b>Pistone da 80N</b><br>Piston 80N<br>Piston 80N  | <b>PI/80</b>        |                         |
|    | <b>Pistone da 160N</b><br>Piston 160N<br>Piston 160N   | <b>PI/160</b>       |                         |
|    | <b>Tubolare per sostegno ripiano</b><br>Worktop support<br>Pied de support pour plan de travail  | <b>TUB</b>          |                         |
|    | <b>Squadretta per sostegno ripiano</b><br>Worktop supporting square<br>Petite equerre de support pour plan de travail                    | <b>SQ</b>           |                         |
|   | <b>Staffa reggipiani</b><br>Support for worktop<br>Etrier porte panneau  | <b>SR</b>           |                         |
|  | <b>Supporto laterale dx - sx</b><br>di sostegno piano<br>Bearing side to support the shelf<br>Panneau latéral de soutien droit ou gauche | <b>SLS/SLD</b>      |                         |
|  | <b>Pannello di chiusura posteriore, al metro</b><br>Back pannel, meter price<br>Panneau arrière meubles, au mètre                        | <b>PCP</b>          |                         |
|  | <b>Pannello di chiusura fra muro e mobile</b><br>Closing pannel between wall and unit<br>Panneau de fond                                 | <b>PMM</b>          |                         |
|   | <b>Tavoletta estraibile</b><br>Side extractable tablet<br>Tablette latérale extractible  | <b>TABEXT</b>       |                         |
|   | <b>Fondo in PVC</b><br>PVC bottom<br>Fond en PVC   | <b>FPVC</b>         | L.34.3 x P.33.2 x H.0.2 |

Euro

**Supporto in plastica per ripiani (confezione 6 pezzi)**

Plastic rest for shelves (pocket of pieces)  
Support en plastique pour étagères (boîte de 6 pièces)

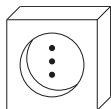
**Presca di corrente**

Current tap  
Prise de courant

PRC

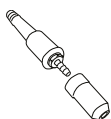
**Siringa ad aria + tubo + raccordo e boccia**

Air-nozzle with pipe + connection + box  
Soufflette avec tuyau + raccordo et emplacement

SIR

**Serratura per cassetto o antina**

Lock for drawer or door  
Serrure pour porte ou tiroir

SERR

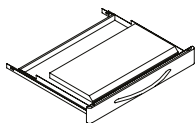
**Cassetto A porta tastiera**

Drawer A - keyboard - holder  
Tiroir A porte - clavier

L.50 x P.47 x H.18.5

CAPT

**Boccola passacavo**

Insert for cable  
Galoche

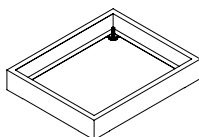
**Zoccolo per Serie Aurora**

Plinth for Aurora Serie  
Socle pour Serie Aurora

ZOC/A

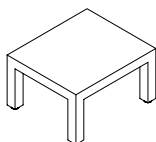
**Zoccolo per Serie Prestige**

Plinth for Prestige Serie  
Socle pour Serie Prestige

ZOC/P

50 cm

100 cm

150 cm

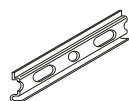

200 cm

**Barra di supporto per pensile PDM, al metro**

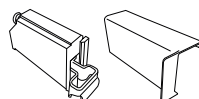
Fixing metal bar for wall unit PDM, per meter  
Support en metal pour le fixage au mur de l'element PDM, au mètre

**Attacchi DX e SX + gusci per pensile**

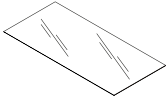
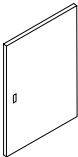
Couplings right and left and covers for wall unit  
Attaques droit at gauche pour element murale

|  | Articolo<br>Article   | Euro |
|--|---|------|
|  | <b>Ripiano in vetro per MV</b><br>Glass shell for MV<br>Rayon en verre pour MV  |      |
|  | <b>Anta scorrevole in vetro per MV</b><br>Sliding glass shutter for MV<br>Porte coulissante en verre pour MV  |      |
|  | <b>Kit 4 ruote con e senza freno per carrello e servomobile</b><br>4 castors with and without brake kit for trolley and mobile element<br>kit 4 roulettes avec et sans frein pour chariot et element mobile |      |



**1) I prezzi degli articoli, resi noti dal presente listino si intendono “al pubblico” I.V.A. esclusa. Per fatture di importo inferiore a 150,00 € verranno addebitate le spese per l'emissione dell'effetto bancario.**

2) Tutte le ordinazioni si intendono assunte salvo il venduto e salvo buone informazioni.

3) La merce viaggia a rischio e pericolo del committente anche se venduta franco destino.

4) La consegna si intende fatta al compratore, a tutti gli effetti, all'atto dell'uscita della merce dai nostri magazzini, venendo con cio' a cessare ogni Nostra responsabilità

5) Non rispondiamo di conseguenza dei ritardi, disguidi, perdite, avarie comunque derivanti dal mezzo di trasporto, né dalla scelta di esso, i reclami contro il vettore debbono essere esercitati dal destinatario.

6) ZILFOR si riserva la facoltà di evadere le commissioni anche in più riprese.

7) I termini di consegna assumono per ZILFOR valore puramente indicativo e non vincolante.

8) Il mancato arrivo delle materie prime adatte va considerato come caso di forza maggiore. In tutti i casi di forza maggiore ZILFOR ha la facoltà di annullare o ritardare l'esecuzione della commissione senza che il committente possa pretendere alcun Indennizzo.

9) Non si accettano reclami se non fatti per lettera raccomandata entro tre giorni dall'arrivo della merce. Per nessun motivo il compratore potrà rifiutarsi allo svincolo delle merci in arrivo; le soste e i conseguenti danni causati dal suo eventuale rifiuto saranno a completo suo carico.

10) La garanzia su eventuali difetti di materiale e fabbricazione segue le disposizioni legislative ed ha una validità di mesi 24 decorrenti dalla data di consegna (e data DDT ).

11) Non si accettano ritorni di merci se non sono stati previamente autorizzati da ZILFOR. Il ritorno viene effettuato solo se la merce è imballata in modo da garantire il trasporto senza ulteriori danni e dovrà essere dotata di regolare documento di accompagnamento, ove dovrà risultare per ciascun articolo il tipo, il colore, la quantità, il numero e la data della fattura di acquisto. L'accredito della merce ritirata viene fatto in base ai prezzi d'acquisto e tenendo conto dello stato di ciascun elemento reso, valutato a insindacabile giudizio del Nostro Ufficio Tecnico.

12) Anche in caso di contestazione di qualsiasi genere e segnalata nel modo richiesto, permane il diritto per ZILFOR di richiedere l'integrale pagamento della fornitura.

13) Per qualunque caso di contestazione unico foro competente è quello di Treviso.

14) In caso di mancato pagamento, salvo ogni nostro diritto, decorrerà l'interesse commerciale.

15) Il mancato pagamento di una scadenza o la mutata situazione del compratore daranno diritto a ZILFOR di annullare senz'altro ogni contratto esistente.

16) La merce rimane fino al suo pagamento di proprietà di ZILFOR che ha la facoltà di ritirarla.

17) Gli elementi fuori serie per dimensioni, per materiale e/o colore devono essere preventivamente accettati dal nostro Ufficio Tecnico sia per la possibilità del tempo di realizzo, sia per la determinazione del prezzo di vendita.

18) ZILFOR declina ogni responsabilità per l'errato montaggio in loco dei suoi articoli non eseguiti dal proprio personale.

19) La conformità “al campione” sia per la prima che per le successive forniture, non va intesa in senso restrittivo giacché sussistono margini di tolleranza di regola riconosciuti per i vari materiali impiegati.

20) ZILFOR si riserva il diritto di variare in qualsiasi dettaglio gli articoli e i prezzi descritti nel presente listino senza doverne dare preavviso alla clientela.

21) Si prega di citare negli ordini il codice completo di ogni prodotto e il relativo prezzo.

22) I depliant in circolazione hanno carattere puramente illustrativo e, pertanto, ZILFOR declina ogni responsabilità per eventuali inesattezze di stampa o per errate indicazioni sulle caratteristiche del prodotto.

23) Le consegne sul territorio nazionale relative a ordini di importo totale netto inferiore a € 800,00 vengono effettuate esclusivamente in porto assegnato. Per cifre superiori il trasporto sarà trattato a parte, indipendentemente dalle modalità di addebito, la merce si intende consegnata al piano cortile, tiro al piano escluso, salvo diverso accordo.

24) I prezzi riportati non comprendono il montaggio che, qualora richiesto, sarà sempre quotato a parte.

**1) The prices of the articles are indicated in this price list and are the “retail prices” excluding VAT.**

- 2) All orders are accepted sale excepted and under usual reserve.
- 3) The goods travel at the buyer's risk even if sold delivery free.
- 4) Delivery is made, to all effects, to the buyer at the moment the goods leave our warehouses, all liability for us thus ceasing from that moment on.
- 5) We cannot be held responsible for the consequences due to delays, miscarriages, losses, damages resulting from the means of transport, neither from the choice of the same; complaints about the carrier must be made by the consignee.
- 6) ZILFOR reserves the right to handle orders also in several instalments
- 7) For ZILFOR, the terms of delivery are given purely as an indication and are not binding
- 8) Failure of suitable raw materials to arrive is considered as Force Majeure. In all cases of Force Majeure, ZILFOR has the right to cancel or delay the completion of orders, without the buyer having the right to claim compensation.
- 9) No complaints are accepted unless sent by registered letter within 3 days from the arrival of the goods. For no reason whatsoever may the buyer refuse to clear the incoming goods, while the demurrage and consequent damage caused by his eventual refusal shall be fully charged to him.
- 10) The guarantee of possible defects about material or concerning the manufacturing follows lowgiving dispositions and has 24 month's validity from delivery date (or from transport document).
- 11) Returned goods will not be accepted unless previously authorised by ZILFOR. Returns are only accepted if the goods are packet in such a way as to guarantee carriage without further damage and shall have a regular packing list, in which the type, colour, quantity, number and date of purchase invoice for each article shall be specified. Credit for the returned goods is made on the basis of the purchase prices and taking into consideration the state of each returned element, assessed by our Technical Office, whose decision is final.
- 12) Also in the case of contestation of any kind whatsoever and notified in the request manner, ZILFOR still has the right to ask for full payment of the supply.
- 13) The only court of competent jurisdiction for any dispute whatsoever is Treviso.
- 14) In the event of non-payment, all our rights being applicable, commercial interest shall be applied.
- 15) Non-payment at a due date or the changed situation of the buyer shall give ZILFOR the right to cancel without further delay all existing agreements.
- 16) The goods remain the property of ZILFOR, who have the right to withdraw them, until full payment is made.
- 17) The elements which are custom-made with regard to dimensions, material and/or colour must be previously accepted by our Technical Office with regards to feasibility, time required for production and calculation of the sale price.
- 18) ZILFOR cannot be held responsible for incorrect assembly of its article on site unless carried out by its own personnel.
- 19) Conformity “to the sample” both for first and subsequent supplies should not be interpreted in a restrictive way, since there are normally recognized margins of tolerance for the various materials used.
- 20) ZILFOR reserves the right to alter any detail of this articles and the prices indicated in this price list without warning its customers.
- 21) When ordering you are requested to quote the complete code number of each product and the relative price.
- 22) Brochures have the sole purpose of illustrating the product and ZILFOR therefore cannot be held responsible for any printing inaccuracies or wrong indications regarding product specifications.
- 23) Deliveries on national territory relating to orders with a net total amount of less than € 800,00 must be made exclusively carriage unpaid. For higher amounts, carriage shall be negotiated separately, independently of the methods of debiting, the goods being delivered to the ground floor, haulage to upper floors excluded, unless otherwise agreed.
- 24) The listed price do not include assembly which, when requested, is always quoted separately.

**1) Les prix des articles sont divulgués par cette liste des prix; ils s'entendent "au public", avec TVA française.**

- 2) Les commandes s'entendent acceptées, sauf le vendu et sauf bons renseignements.
- 3) La marchandise voyage aux risques et périls de l'acquéreur, même si vendue franco à destination
- 4) La livraison s'entend effectuée à l'acquéreur, à tous les effets, au moment de la sortie de la marchandise de nos magasins; cessant par cela toute responsabilité de notre part.
- 5) Nous ne répondons pas des conséquences causées par les retards, erreurs, pertes ou avaries dérivant aussi bien du moyen de transport que de la choix de celui-là; toute réclamation au transporteur doit être exercée par le destinataire.
- 6) ZILFOR se réserve le droit d'exécuter également les commandes même par plusieurs livraisons partielles.
- 7) Les conditions de livraison ont pour ZILFOR une valeur purement indicative et non contraignante.
- 8) La non-livraison des matières premières appropriées constitue un cas de force majeure. Dans tous les cas de force majeure ZILFOR a la faculté d'annuler ou de retarder l'exécution de la commande sans que le client puisse exiger une indemnité.
- 9) On n'accepte autre réclamation que par lettre recommandée dans un délai trois jours dès réception de la marchandise. Pour aucune raison l'acheteur ne pourra se refuser d'accepter les marchandises entrantes; les arrêts et les dommages conséquents causés par un refus éventuel seront entièrement à sa charge.
- 10) La garantie concernant éventuels défauts du matériel ou de fabrication suite les dispositions législatives et a une validité de 24 mois à partir de la date de livraison ( ou date document de transport).
- 11) Aucune marchandise de retour ne sera acceptée si ZILFOR ne l'a pas autorisé préalablement. Le retour sera effectué seulement si la marchandise est emballée de façon à garantir son transport sans dommages ultérieurs. Elle devra être accompagnée du document d'accompagnement régulier, où l'on mentionnera le type, la couleur, la quantité, le numéro et la date de la facture d'achat de chaque article. L'avis relatif à la marchandise retirée sera calculé sur la base des prix d'achat, en prenant en considération l'état de chaque élément rendu, évalué sur la base de la décision sans appel de notre Service Technique
- 12) Même en cas de contestation, de quelle que nature que ce soit, et signalée de la façon requise, ZILFOR garde également le droit de demander le paiement intégral de la commande.
- 13) Dans tous les cas de contestation le tribunal de Treviso est le seul compétent.
- 14) En cas de non-paiement, sauf tous nos droits, on va calculer l'intérêt commercial.
- 15) Le non-paiement d'une échéance ou la situation changée de l'acquéreur donneront à ZILFOR le droit d'annuler tout contrat existant.
- 16) Jusqu'à son paiement, la marchandise reste propriété de ZILFOR qui a faculté de la retirer.
- 17) Tout élément hors série par dimensions, matériau et ou couleur doit être accepté préalablement par notre Service Technique en ce qui concerne la possibilité du temps de réalisation, et la détermination du prix de vente.
- 18) ZILFOR décline toute responsabilité pour l'incorrect monitoring sur place de ses articles qui n'a pas été effectué par son personnel.
- 19) La conformité "à l'échantillon", aussi bien pour la première fourniture que pour toute fourniture suivante, ne s'entend pas dans un sens restrictif, puisque il y a des marges de tolérance qui en règle générale sont reconnus aux différents matériaux employés.
- 20) ZILFOR se réserve le droit de modifier tout détail de ses articles et les prix indiqués dans cette liste des prix, sans devoir en donner le préavis à sa clientèle.
- 21) Nous vous prions d'indiquer le code complet de chaque produit et le prix correspondant dans la commande.
- 22) Les dépliants en circulation sont à caractère purement explicatif; ZILFOR décline toute responsabilité pour les inexactitudes d'impression éventuelles ou pour des indications incorrectes des caractéristiques du produit.
- 23) Toute livraison sur le territoire national relative à des commandes dont le montant net total est inférieur à € 800,00 est effectuée exclusivement en port dû. Pour des montants supérieurs le transport sera déduit à part, indépendamment des modalités de débit. Il est entendu que la marchandise est livrée au niveau de la cour, livraison à l'étage non-compris, sauf accords différents.
- 24) Les prix indiqués ne comprennent pas le montage. Sur demande, on fera toujours une cotation séparée.

