



Please carefully read this Manual before first operation

# *PT-A Dental Scaler and Air Polisher Instruction Manual*

CE 0197



[www.glwoodpecker.com](http://www.glwoodpecker.com)

**GUILIN WOODPECKER MEDICAL INSTRUMENT CO., LTD.**

## Contents

Forward .....	1
1 Introduction.....	1
2 Installation.....	4
3 Function and operation .....	7
4 Troubleshooting .....	12
5 Cleaning, disinfection, and sterilization.....	15
6 Maintenance, storage, and transport .....	20
7 Environmental protection.....	21
8 After service .....	21
9 Manufacturer's right .....	21
10 Symbol instruction .....	22
11 European authorized representative .....	23
12 EMC-Declaration of conformity .....	23
13 Statement.....	27

## **Forward**

Guilin Woodpecker Medical Instrument Co., Ltd is a professional manufacturer researching, developing, and producing dental products. Woodpecker owns a sound quality control system and two brands, Woodpecker and DTE. Its main products include Ultrasonic air polishing Periodontal Treatment Device, Ultrasonic Scaler, Curing light, Apex locator, Ultrasurgery, automatic water supply system, etc.

## **1 Introduction**

### 1.1 Brief introduction

PT-A Dental Scaler and Air Polisher has both ultrasound system and air polishing system. It is suitable for periodontal treatment and root canal irrigation in dental clinical treatment. It can remove subgingival and supragingival calculus and plaque, so as to achieve the therapeutic effect of consolidating periodontal tissue. The features of this device are:

- 1) According to the selected handpiece, automatically switch the working mode.
- 2) The front panel adopts touch LCD screen, and the function selection and working status indication are simple and clear.
- 3) The rounded vibration trajectory of the tip realizes treatment and polishing at the same time. With small amplitude of tip, achieve painless treatment.
- 4) Titanium alloy tip will not hurt cementum or enamel.
- 5) In the automatic water supply mode, special chemical solutions such as hydrogen peroxide, sodium hypochlorite and chlorhexidine can be used to improve the clinical treatment effect.
- 6) The automatic frequency tracking system is used to automatically search for the best working condition, which brings more stable performance of device.
- 7) The three-piece design of air polishing handpiece is easy to load and unload for cleaning and maintenance.
- 8) The powder tank adopts a side cone structure to effectively reduce the residual amount of powder.
- 9) Detachable ultrasonic handpiece and air polishing handpiece can be sterilized under high temperature of 134°C and high pressure of 0.22MPa.
- 10) The working process is fully automatic controlled by microcomputer, which is convenient and simple to operate and if of high efficiency.

### 1.2 Model

PT-A

### 1.3 Device configuration

Please refer to the packing list for device configurations.

### 1.4 Structure and components

It consists of main unit, water bottle, powder tank, prophylaxis powder (Sodium

bicarbonate, hydrophobic silica, edible essence), air polishing handpiece, ultrasonic handpiece, working tips, sand blasting nozzle, power adapter and foot pedal, etc.

Applied part: working tips, sand blasting nozzle.

## 1.5 Scope of application

### 1.5.1 Ultrasound system

#### ① Scaling

- Removal of supragingival calculus
- Removal of stains

#### ② Endo

- Preparation, cleaning and irrigation of root canals
- Retrograde preparation of root canals
- Condensing gutta-percha
- Removal of crown, bridges and restorations

#### ③ Restorative

- Cavity preparation
- Luting inlays and onlays
- Condensing of amalgams

#### ④ Perio

- Scaling and root planing
- Periodontal treatments

### 1.5.2 Air polishing system

- Remove dental plaque
- Surface preparation before bonding/cementation of inlays, onlays, crowns and veneers

- Perform the tooth surface preparation before placing the composite restoration.
- Cleaning before sticking orthodontic brackets
- Effectively remove plaque and tartar for orthodontic patients
- Cleaning the implant fixture before loading
- Stain removal for shade determination
- Remove plaque before fluoride treatment
- Remove plaque and tartar before whitening procedure

## 1.6 Contraindications

1.6.1 The hemophilia patient is forbidden to use this equipment.

1.6.2 The patients with heart pacemaker are forbidden to use this equipment.

1.6.3 The doctors with heart pacemaker are forbidden to use this equipment.

1.6.4 Heart disease patients, pregnant women and children should be cautious to use the equipment.

1.6.5 Patients with respiratory diseases such as asthma and chronic bronchitis are not allowed to use this device.

1.6.6 Patients with a low-salt diet are prohibited from air polishing function.

## 1.7 Device safety classification

- 1.7.1 Classified by operation mode: Continuous operating device
- 1.7.2 Type of protection against electric shock: Class I
- 1.7.3 Degree of protection against electric shock: B type applied part
- 1.7.4 Degree of protection against harmful ingress of water: Ordinary equipment (IPX0). Foot pedal is anti-drip device (IPX1)
- 1.7.5 Degree of safety application in the presence of a flammable anesthetic mixture with air, oxygen, or nitrous oxide: Equipment cannot be used in the presence of a flammable anesthetic mixture with air, oxygen, or nitrous oxide.

## 1.8 Main technical specification

- 1.8.1 Power adapter input: 220-240V~ 50Hz/60Hz 400mA
- 1.8.2 Power adapter output: 25V~ 50Hz/60Hz 2.8A
- 1.8.3 Main unit input: 25V~ 50Hz/60Hz 2.8A
- 1.8.4 Output main vibration offset of tip (maximum): 90 $\mu$ m;  
Deviation: +50%
- 1.8.5 Output vibrating frequency of tip: 30 $\pm$ 5kHz
- 1.8.6 Output semi- (maximum)offset force: 5N Deviation: +50%
- 1.8.7 Output power of tip: 3W~20W
- 1.8.8 Main unit fuse: T5AH 250V
- 1.8.9 Power adapter fuse: T1.0AL250V
- 1.8.10 Water inlet pressure: 1bar~5bar (0.1MPa~0.5MPa)
- 1.8.11 Air inlet pressure: 5.5bar~7.5bar (0.55MPa~0.75MPa)
- 1.8.12 Water outlet temperature of air polishing system: 0~45 $^{\circ}$ C
- 1.8.13 Main unit weight: 2.75Kg
- 1.8.14 Main unit size: 330mm $\times$ 280mm $\times$ 120mm

## 1.9 Operation environment

- 1.9.1 Environmental temperature: +5 $^{\circ}$ C~ +40 $^{\circ}$ C
- 1.9.2 Relative humidity: 30% ~ 75%
- 1.9.3 Atmospheric pressure: 70kPa~106kPa
- 1.9.4 Cooling water temperature: +5 $^{\circ}$ C~ +25 $^{\circ}$ C

## 2 Installation

### 2.1 Front view of the main unit

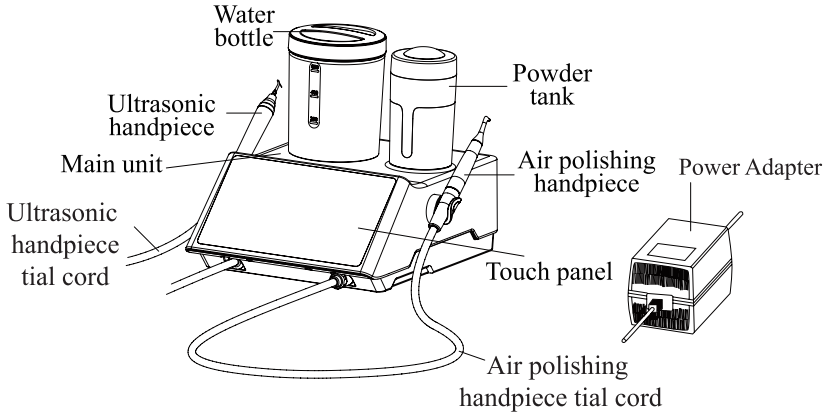

Figure 1 Front view of main unit

### 2.2 Rear view of the main unit

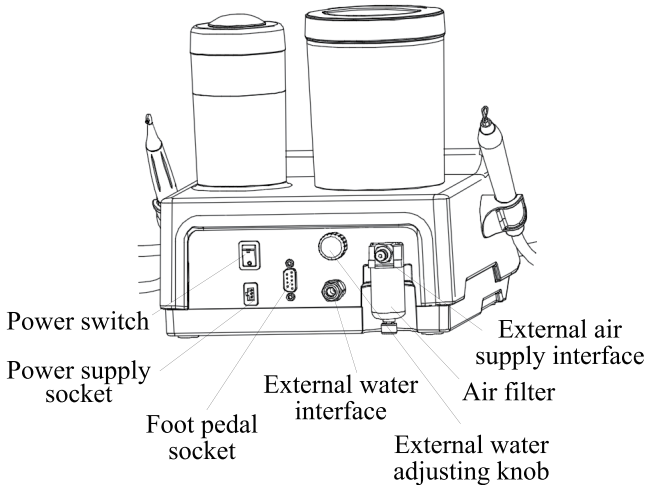

Figure 2 Rear view of the main unit

## 2.3 Touch panel



 Scaling    Ultrasonic scaling

 Air Polishing    Air polishing scaling

 Purge    Cleaning mode

- G**    Scaling/supragingival air polishing
- P**    Perio/subgingival air polishing
- E**    Endodontic treatment
- Turn down water volume/power/air pressure
- +**    Turn up water volume/power/air pressure



## Setting

Figure 3 Schematic diagram of touch panel

### 2.3 Schematic diagram of handpiece

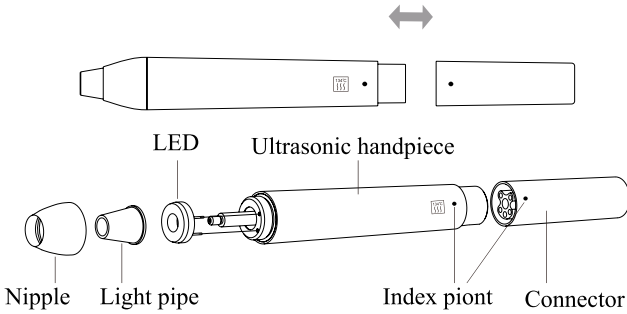

Figure 4 Ultrasonic handpiece

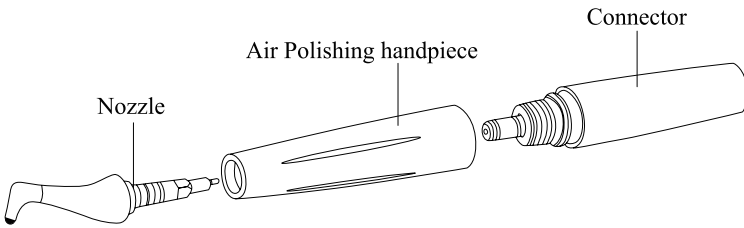

Figure 5 Air polishing handpiece

### 2.4 Schematic diagram of tip installations

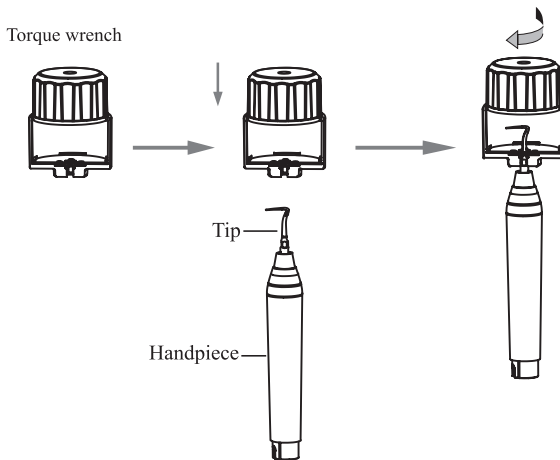

Figure 6 Schematic diagram of tip installation



## 2.5 Installation procedures

- ① Open the package, check whether the equipment is complete as per the packing list, and place the main unit on a solid plane, holding it directly facing the operator.
- ② Connect the power adapter with main unit.
- ③ Plug the external air pipe connector into the air intake connector on the back of the main unit.

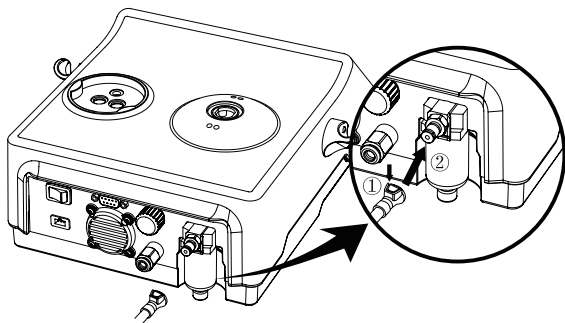

Figure 7 Schematic diagram of external air pipe installation

- ④ Insert the foot pedal plug into the foot switch socket.
- ⑤ Connect the ultrasonic handpiece and air polishing handpiece with corresponding tail cords respectively, and place the handpieces on the brackets on both sides of the main unit. The ultrasonic handpiece is on the left and the air polishing handpiece is on the right.

**Warning1:** When the machine is connected to the network power supply, the protection ground must be linked.

**Warning2:** When the machine is connected to the network power supply, do not place or install the product where it is difficult to disconnect the network power supply.

## 3 Function and operation

### 3.1 Multi-function foot pedal

- ① According to the installation procedures, insert the foot pedal plug into the main unit, tighten it, and place the foot pedal face up on a flat surface.
- ② The multi-function pedal is as shown in the figure, and the functions of each button are as follows:

Button	Working mode	Function	
		Ultrasound system	air polishing system
A	Standard	Vibration + water	Air, powder + water
B	Anhydrous mode	Vibration	Air only
C (+A)	Enhance <b>【Note】</b>	Power increases by two levels	Air pressure increases by two levels

D	Irrigation	Only water spray	Air+Water
---	------------	------------------	-----------

**【Note】** In the Enhance mode, the power/air pressure is increased by three levels based on the original level, and the maximum is level 12. When the pedal button C is released, the gear position is automatically restored to the previously set gear position.

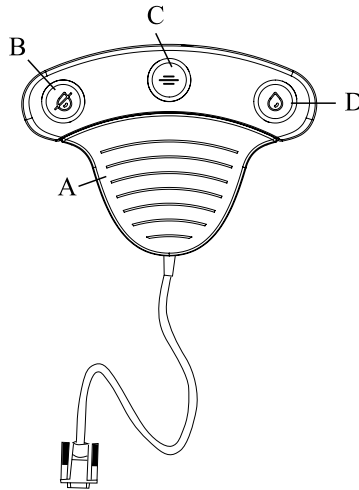

Figure 8 Schematic diagram of multi-function foot pedal

### 3.2 Ultrasound system

#### 3.2.1 Scaling

1. Install the product correctly according to the product installation steps, and the operator is facing the machine.
2. Turn on the power switch on the main unit and pick up the ultrasonic handpiece. At this time, the panel automatically jumps into the Ultrasound system interface.
3. This machine uses the touch panel. Directly click the “G” on the panel to enter the teeth scaling mode.
4. Select the appropriate water supply method and click on the water bottle/faucet icon on the panel to switch between water bottle supply and external water.
5. Select proper tip as per need, and use torque wrench to tighten it to the handpiece.
6. When the foot button A is pressed, the tip vibrates, and the LED light on the head of handpiece is illuminated, accompanied by the cooling water spray (For the first time after booting, as there is more air in the pipeline, it takes a few seconds to drain.) After releasing the foot pedal, the vibration and water spray stop, and the LED light continues to light for 10 seconds and then goes out.
7. Generally, hold the handpiece with the gesture of holding a pen.
8. The frequency of the tip is extremely high. In the condition of normal tip vibration and water spray, lightly touch the tooth surface with the side of tip and move in a certain to-and-fro motion to eliminate the calculus without obvious heating. Avoid local over-

rextion or overstay in scaling.

9. Vibrating intensity: Adjust the vibrating intensity according to your need. Generally start with level 1 power, and adjust the vibrating intensity according to the teeth sensitivity and hardness of calculus during clinical application.

10. Water volume: For water bottle supply mode, click the water volume adjusting knob on penal to adjust. For external water supply mode, adjust the water volume through the water volume adjusting knob on the back of main unit.

11. In clinical scaling, please keep the side of the tip in contact with and parallel to the tooth surface. Do not apply pressure so as to allow the tip to vibrate freely.

12. After operation, please keep device working for 30s with water supply to wash the handpiece and tips.

13. Remove the tip for disinfection.

### 3.2.2 Ultrasonic periodontal treatment

1. Use a torque wrench to tighten the periodontal treatment tip to the ultrasonic handpiece. Click the “P” key on panel to enter the periodontal treatment mode.

2. The rest of the operation and adjustment methods are similar to the ultrasonic scaling mode.

### 3.2.3 Endodontic irrigation

1. Tighten the Endo file to the Ultrasonic handpiece with Endo wrench.

2. Click the “E” key on panel to enter the Endodontic irrigation mode.

3. After switching to the Endodontic irrigation mode, the default power level is level 1. Select higher power level according actual need during clinical treatment.

4. Select the appropriate Endo file and slowly place it into the root canal of the patient’s teeth. Start the foot pedal to perform ultrasonic endodontic irrigation.

5. When the Endo file is in the root canal, please do not the press it too tight.

6. Only after the Endo file is in the root canal can the foot pedal can be activated.

7. The recommended power level of Endodontic irrigation is level 1 – level 5.

## 3.3 Air polishing system

1. Add appropriate amount of powder to the supragingival powder tank (the amount of powder should to be controlled between the “Max” amount and “Min” amount on the surface of the tank), then tighten the cover of powder tank and plug the powder tank into the powder tank socket just above the device.

2. Pick up the air polishing handpiece, the panel automatically jumps to working interface of air polishing mode.

3. Click the panel to adjust the water volume to the maximum level (level 12), adjust the air pressure (POWER) to level 1, align the nozzle with the pool, and press the button A on foot pedal to confirm whether the nozzle can normally emit gas, powder and water mist. The device can be used later after the nozzle can normally emit gas, powder and water mist.

4. Before air polishing treatment, please help patient to wear the goggles and give patient a mask to cover the face or let. And the users should wear goggles or a protective mask.

5. Generally, hold the handpiece with the gesture of holding a pen.
6. Adjust the water volume and air pressure to appropriate level. Normally the water volume starts with level 5, and air pressure starts with level 1. During clinical application, adjust the water volume and air pressure according to the teeth sensitivity and dental plaque condition. Increase of air pressure will enhance the cleaning effect, but will weaken the polishing effect. Increase of water volume will enhance the polishing effect, but weaken the cleaning effect.
7. During scaling, align the nozzle with the tooth surface, but not directly contact it. Keep it 3-5mm away from the tooth surface at the angle of 30°-60°. The smaller the angle, the bigger the cleaning area will be. During scaling, please perform a small circular motion on the tooth surface. Do not point the nozzle at the gums or periodontal parts.
8. The air/powder mixture reflected from the tooth surface should be evacuated by using a strong suction device on the dental unit during treatment.
9. After treatment, adjust the water volume to the maximum level, and polish the surface of all teeth.

### 3.4 Cleaning mode

It is recommended to flush and disinfect the pipe of the unit daily. The Cleaning mode allows the pipes to be cleaned and disinfected to reduce crystal accumulation and the amount of bacteria in the pipe.

1. Fill the water bottle with distilled or dematerialized water.
2. Pick up the ultrasonic handpiece, point the handpiece at the sink, click the “Cleaning” button on the screen, and press the button D on foot pedal to start cleaning the pipeline. At this time, the pedal can be released.
3. After cleaning for 30 seconds, the device will automatically stop the “Cleaning” mode. You can also press the button D on foot pedal again in the “Cleaning” mode or click “Purge” on the screen to stop cleaning.
4. After cleaning, put the ultrasonic handpiece back into the bracket. And then, pick up the air polishing handpiece, point the handpiece nozzle at the pool, and click the “Cleaning” button again, so that the device will automatically blow out the residual powder in the pipeline and release the high pressure gas in powder tank.
5. After cleaning for 20 seconds, the device will automatically exit the “Cleaning” mode. You can also click “Purge” on the screen to stop cleaning.

### 3.5 Function setting

Click the Setting key on the panel to enter the setting interface for language selection and the start or closure of heater. The power and water volume are automatically restored to the gear positions set at the factory when you click the ‘Restore the factory setting’.

### 3.6 Precautions

1. Please keep the device clean before and after operation.

2. Allow the machine to work with water for 10 seconds before each clinical operation to remove any water remaining in the pipe.

3. Operators should be equipped with adequate protection (e.g., goggles, masks, etc.) to prevent cross-contamination.

4. Product use must comply with the relevant operation specifications and relevant regulations of the medical department. And the operation is limited to trained doctors or technicians.

5. Before each operation, please disinfect the accessories such as ultrasonic handpiece, tip, torque wrench, air polishing handpiece and nozzle.

6. Please do not load or unload the tip while stepping on the foot pedal or the handpiece is vibrating.

7. Do not step on the foot pedal button while the tail cord of the air polishing handpiece has been removed from the main unit.

8. Before using the ultrasonic handpiece, make sure that the tail cord of the air polishing handpiece is correctly placed on the handpiece bracket; similarly, before using the air polishing handpiece, make sure that the ultrasonic handpiece tail plug is correctly placed on the ultrasonic handpiece bracket.

9. The tip must be tightened.

10. When the tip is damaged or worn, the vibration intensity will decrease. The operator should replace it with a new one in time according to the clinical situation.

11. Do not bend or grind the tip.

12. If the equipment is used in the anhydrous mode for a while, the temperature of the tip may be more than 51 °C. It is recommended that the tip continuously works for 2 seconds and pause for at least 15 seconds in the anhydrous mode.

13. Under no circumstances should the air polishing handpiece nozzle be aimed at people.

14. If the powder accidentally sprays into the eyes, it may damage eyes. We strongly recommend that all personnel (doctors, nurses, patients) wear goggles during air polishing treatment.

15. During the air polishing process, if you need to add powder to the powder tank, please click the "Cleaning" key on the screen, wait for the internal pressure of the powder tank to be released, then remove the powder tank from the machine and load the appropriate amount of powder.

16. Before replacing the air polishing handpiece or the nozzle, please use a syringe to blow the moisture at the joints at both ends (especially the gas interface) to prevent moisture from entering the gas path and avoid clogging of the powder in the pipeline.

17. Do not use unclean water.

18. If a pressureless water source is used, the water surface of the pressureless water source should be more than one meter above the patient's head.

19. Do not pull the tail cord hard during the use of the device to avoid damage to the tail cord.

20. Do not hit or scratch the handpiece.

21. After operation, turn off the power supply and unplug the power plug.

22. If there is any problem with the power adapter, please return it to the manufacturer or have it repaired by an authorized professional.

23. Our company is specialized in the production of medical devices. Only when the maintenance, repair and modification of the machine is carried out by our company or our authorized dealer, the replacement parts are the Woodpecker accessories and the operation is in accordance with the instruction manual, we are responsible for its security.

24. The inner thread of the tip manufactured by certain manufacturers are rough, rusty and will break the teeth or adopt other thread system, the combination between the above mentioned inner thread with our handpiece will damage the outer thread of handpiece, which will cause irreparable damage to the scaler. Please use corresponding tips of the Woodpecker brand.

25. If you find that the sealing ring is damaged when using PT-A, please refer to the annex Sealing Ring Specifications in the Manual and get it replaced with suitable sealing ring. There are seals of various specifications in the supplied accessories. If you have any questions, please contact the manufacturer or local distributor.

## 4 Troubleshooting

### 4.1 Troubleshooting

Fault	Possible cause	Solutions
The tip does not vibrate and there is no water spray after power on and stepping on the foot pedal.	Loose contact of power supply plug.	Plug the power supply plug well.
	Loose contact of foot pedal.	Plug the foot pedal plug well.
	The fuse is broken.	Contact local distributor or manufacturer.
	The bracket switch does not pop up.	Move the bracket switch to make it pop up smoothly.
The tip does not vibrate and there is water spray after power on and stepping on the foot pedal.	Loose tip	Tighten the tip (figure 6)
	The connection between the tail wire and the circuit board is loose.	Contact local distributor or manufacturer.
	Handpiece failure	Contact local distributor or manufacturer.
	Tail cord failure	Contact local distributor or manufacturer.

The tip vibrates but there is no water spray after power on and stepping on the foot pedal.	Water volume adjustment knob is not open.	Open the water volume adjustment knob. <b>【Note1】</b>
	Wrong selection of water supply mode	Keep the water supply mode displayed on screen consistent with the actual water supply.
	Filter clogging	Clean the filter
	Impurity in the solenoid valve	Contact local distributor or manufacturer.
	Water line clogging	Use syringe to drain.
After power-off, there is still water spray.	Impurity in the solenoid valve	Contact local distributor or manufacturer.
Heating handpiece	Water volume is too small	Turn up the water volume. <b>【Note1】</b>
	Device fault	Contact local distributor or manufacturer.
The effluent water temperature is too high (over 45 °C)	Thermocouple failure	Contact local distributor or manufacturer.
Water spray is too small	Water volume is too small	Turn up the water volume. <b>【Note1】</b>
	Water pressure is not enough	Increase the water pressure
	Water line clogging	Use syringe to drain.
Weakened tip vibration	Tip is not tightened.	Tighten the tip (Figure 6)
	Tip is loose	Tighten the tip (Figure 6)
	Broken tip <b>【Note2】</b>	Replace the tip
The Endo file does not vibrate	The nut is not tightened	Tighten the nut
There is no air spray and water spray after power on and stepping on the foot pedal.	Loose contact of power supply plug.	Plug the power supply plug well.
	Loose contact of foot pedal.	Plug the foot pedal plug well.
	The bracket switch does not pop up.	Move the bracket switch to make it pop up smoothly.
The nozzle does not spray gas but there is water spray after power on and stepping on the foot pedal.	Nozzle clogging	Dredge the nozzle
	Handpiece clogging	Dredge the handpiece
	Clogging of handpiece tail cord	Remove the tail cord from the main unit, dredge the tail cord or replace it.
	Solenoid valve failure	Contact local distributor or manufacturer.

There is air flow but no water spray after power on and stepping on the foot pedal.	Water volume adjustment knob is not open.	Open the water volume adjustment knob. <b>【Note1】</b>
	Wrong selection of water supply mode	Keep the water supply mode displayed on screen consistent with the actual water supply.
	Filter clogging	Clean the filter
	Impurity in the solenoid valve	Contact local distributor or manufacturer.
	Water line clogging	Contact local distributor or manufacturer.
Leaking air of powder tank	The O-ring on base of powder tank is broken.	Contact local distributor or manufacturer.
	The rubber ring on upper cover of powder tank is broken.	Replace the rubber ring.
	There is powder residue at the thread, so that the screw is not in place.	Remove the residual powder at the thread part.
	The upper cover of powder tank is broken.	Replace the upper cover of powder tank.
	The thread of powder tank is broken so that the screw is not in place.	Replace the upper cover of powder tank.
Water leakage of air polishing handpiece	Broken O-ring of handpiece	Replace the O-ring
The air powder scaling efficiency is reduced.	The powder in tank is not enough.	Add powder to the tank.
	Powder residue in pipe, handpiece, or nozzle passage	Clean the passage with a fine needle and blow it off with compressed air.
Touch panel pops up prompt message	No powder chamber	Check the powder chamber and reinstall.
	Insufficient pressure	Increase pressure of external air.
	Do not take two handpieces at the same time	Choose one handpiece when working and put another one back into the bracket.
	Please adjust water volume by the knob	Use the knob on the rear of main unit to adjust water volume when in the external water mode.
	Heating system failure! Please stop heating.	Turn off heating and contact local distributor or manufacturer.

Note: if the problems cannot be solved, please contact local distributor or manufacturer.



## 4.2 Notice

【Note1】 As shown in the picture, the water volume can be increased or decrease through adjusting the water volume adjustment knob.

【Note2】 If the tip is surely tightened and there is water mist spray, the tip is considered to be damaged with the following phenomena:

- 1) The vibration intensity of the tip and the degree of water atomization are significantly weakened.
- 2) The tip makes a harsh “click” sound during operation.

## **5 Cleaning, disinfection, and sterilization**

### 5.1 Initial processing

#### 5.1.1 Processing principles

It is only possible to carry out effective sterilization after the completion of effective cleaning and disinfection. Please ensure that, as part of your responsibility for the sterility of products during use, only sufficiently validated equipment and product-specific procedures are used for cleaning/disinfection and sterilization, and that the validated parameters are adhered to during every cycle.

Please also observe the applicable legal requirements in your country as well as the hygiene regulations of the hospital or clinic, especially with regard to the additional requirements for the inactivation of prions.

#### 5.1.2 Post-operative treatment

The post-operative treatment must be carried out immediately, no later than 30 minutes after the completion of the operation. The steps are as follows:

Let the device work for 20-30 seconds at maximum water volume to separately flush the Ultrasonic handpiece, tip, Air polishing handpiece, and nozzle;

Remove the handpieces from the device and rinse away the dirt on the surface of handpieces and their accessories (tip, nozzle and torque wrench) with pure water (or distilled water/deionized water);

Dry the handpieces and its accessories with a clean, soft cloth and place it in a clean tray.

Precautions:

- 1) The water used here must be pure water, distilled water or deionized water.

### 5.2 Cleaning

The cleaning of handpiece and its accessories should be performed no later than 24 hours after the operation.

The cleaning can be divided into automated cleaning and manual cleaning. Automated cleaning is preferred if conditions permit.

#### 5.2.1 Automated cleaning

The cleaner is proved to be valid by FDA, CE certification or in accordance with EN ISO 15883.

There should be a flushing connector connected to the inner cavity of the product.

The cleaning procedure is suitable for the handle, and the flushing period is sufficient. But ultrasonic cleaning is not allowed for Ultrasonic handpiece.

It is recommended to use a washer-disinfector in accordance with EN ISO 15883. For the specific procedure, please refer to the automated disinfection section in the section “Disinfection”.

Precautions:

1) The cleaning agent does not have to be pure water. It can be distilled water, deionized water or multi-enzyme. But please ensure that the selected cleaning agent is compatible with the handpiece.

2) The water temperature should not exceed 45°C, otherwise the protein will solidify and it is difficult to remove.

### 5.2.2 Manual cleaning

· Soak the handpieces and its accessories in a cleaning agent (such as multi-enzyme). The soaking time and concentration should at least reach the time and concentration specified by the detergent manufacturer;

· Carefully clean the surface of the handpieces and its accessories with a disposable soft cloth or soft brush to remove any visible dirt on the surface;

· Rinse the handpieces and its accessories under clean running water (desalted water, distilled water or deionized water) for at least 5 times with duration of no less than 60 seconds for each time.

· Check whether the cleaned parts are clean or damaged. If the cleaning is not complete, repeat the previous cleaning procedures.

The intrinsic suitability of the handpieces and its accessories for effective cleaning using the above procedure was verified by a validated facility.

Precautions:

1) The cleaning agent used here must be compatible with the handpieces and only freshly prepared solutions can be used.

2) The water temperature should not exceed 45°C, otherwise the protein will solidify and it is difficult to remove.

## 5.3 Disinfection

Disinfection must be performed no later than 2 hours after the cleaning phase. Automated disinfection is preferred if conditions permit.

### 5.3.1 Automated disinfection

If possible, the disinfection cycle should be in accordance with EN ISO 15883. Please ensure that the following standards are met when selecting a sterilizer system:

- The sterilizer is FDA approved, CE certified or in accordance with EN ISO 15883.
- Use high temperature disinfection function. The temperature does not exceed 134 °

C. The temperature cannot exceed 20 minutes.

- The sterilizer has a flush connecting piece that is connected to the interior of the handpiece.

- The cleaning procedure is suitable for the handle and the flushing cycle is sufficient (5-10 minutes).

- Only distilled or deionized water with a small amount of microorganisms (<10 cfu/ml) can be used for all rinsing steps. (For example, pure water that is in accordance with the European Pharmacopoeia or the United States Pharmacopoeia).

- The air used for drying must be filtered by HEPA.

- Regularly repair and inspect the disinfectant.

Cleaning and disinfecting steps by using Washer-disinfectant

Carefully place the handpieces and its accessories in the disinfection basket. Fastening of the handpieces and its accessories if only permissible if they are freely moveable in the fixture. The handpieces and its accessories are not permitted to make contact with one another.

Use a suitable rinsing adaptor, and attach the handpieces to the rinsing connections of the washer-disinfectant so that the surface and internal water lines can be flushed during cleaning process.

Start the program.

After the program is finished, remove the handpieces and its accessories from the washer-disinfectant, inspect (refer to section “Inspection and Maintenance”) and packaging (refer to chapter “Packaging”). Dry the handpieces and its accessories repeatedly if necessary (refer to section “Drying”).

The intrinsic suitability of the handpieces and its accessories for effective cleaning and disinfection using the above automated cleaning and disinfection procedures was verified by a certified facility. (Use the washer-disinfectant of Shandong Xinhua Medical Instrument Co., Ltd. located in Zibo City, Shandong Province, which complies with EN ISO 15883).

Precautions:

- 1) Before use, you must carefully read the operating instructions provided by the equipment manufacturer to familiarize yourself with the disinfection process and precautions.

- 2) With this equipment, cleaning, disinfection and drying will be carried out together.

- 3) Cleaning: (a) The water temperature should not exceed 45°C, otherwise the protein will solidify and it is difficult to remove. (b) The solution used can be pure water, distilled water, deionized water or multi-enzyme solution, etc., and only freshly prepared solutions can be used. (c) The cleaning agent must be compatible with the handpiece. Please follow the concentration and contact time provided by manufacturer.

### 5.3.2 Manual disinfection

Tools: containers for disinfectant, water guns, air guns, trays

Place the handpieces and its accessories in a disinfectant (e.g.75% medical alcohol or 2% glutaraldehyde solution) for at least the time specified by the manufacturer.

Remove the handpieces and its accessories from the disinfectant and rinse it with purified water, distilled water or deionized water for at least 5 times for not less than 60

seconds of each time.

Dry the handpieces and its accessories with filtered compressed air (maximum pressure: 3 bar).

After the program is finished, remove the handpieces and its accessories from the washer-disinfector, inspect (refer to section “Inspection and Maintenance”) and packaging (refer to chapter “Packaging”). Dry the handpieces and its accessories repeatedly if necessary (refer to section “Drying”).

Verification of the fundamental suitability of the handpieces and its accessories for effective manual cleaning and disinfection was provided by a verified testing laboratory.

Precautions:

1) The disinfectant used to configure the disinfectant must be compatible with the handpieces and cleaning agent, and must be tested effective (e.g., DGHM, FDA approved or CE certified).

2) The disinfectant must be used in accordance with the concentration and contact time specified by manufacturer.

3) The disinfectant used must be freshly prepared solutions and no foaming is allowed.

#### 5.4 Drying

If your cleaning and disinfection process does not have an automatic drying function, dry it after cleaning and disinfection.

Methods:

1) Spread a clean white paper (white cloth) on the flat table, point the handpieces and its accessories against the white paper (white cloth), and then dry the handpieces and its accessories with filtered dry compressed air (maximum pressure 3 bar). Until no liquid is sprayed onto the white paper (white cloth), the drying is completed.

2) It can be dried directly in a medical drying cabinet (or oven). The recommended drying temperature is 80°C~120°C and the time should be 15~40 minutes.

Precautions:

1) The drying of product must be performed in a clean place.

2) The drying temperature should not exceed 138°C;

3) The equipment used should be inspected and maintained regularly.

#### 5.5 Inspection and maintenance

1) Check the handpieces and its accessories. If there is still visible stain on the handpieces and its accessories after cleaning/disinfection, the entire cleaning/disinfection process must be repeated.

2) Check the handpieces and its accessories. If it is obviously damaged, smashed, detached, corroded or bent, it must be scrapped and not allowed to continue to be used.

3) Check the handpiece. If the structural parts (O-ring, LED light, light guide, etc.) are broken, please replace it before use. But the replaced parts must be cleaned, disinfected and dried.

4) If the service time (number of times) of the Ultrasonic handpiece reaches the specified service life (number of times), please replace it in time.

5) Do not use the machine when the machine is being cleaned/disinfected/sterilized.

## 5.6 Packaging

The disinfected and dried handpieces and their accessories are assembled and quickly packaged in a medical sterilization bag (or special holder, sterile box).

Precautions:

1) The package used conforms to ISO 11607;

2) It can withstand high temperature of 138°C and has sufficient steam permeability;

3) The packaging environment and related tools must be cleaned regularly to ensure cleanliness and prevent the introduction of contaminants;

4) Avoid contact with parts of different metals when packaging.

## 5.7 Sterilization

Use only the following steam sterilization procedures (fractional pre-vacuum procedure\*) for sterilization, and other sterilization procedures are prohibited:

The steam sterilizer complies with EN13060 or is certified according to EN 285 to comply with EN ISO 17665;

The highest sterilization temperature is 138°C;

The sterilization time is at least 4 minutes at a temperature of 132°C / 134°C and a pressure of 2.0 bar ~ 2.3 bars.

Allow a maximum sterilization time of 20 minutes at 134°C.

Verification of the fundamental suitability of the products for effective steam sterilization was provided by a verified testing laboratory.

Precautions:

1) Only products that have been effectively cleaned and disinfected are allowed to be sterilized;

2) Before using the sterilizer for sterilization, read the Instruction Manual provided by the equipment manufacturer and follow the instructions.

3) Do not use hot air sterilization and radiation sterilization as this may result in damage to the product;

4) Please use the recommended sterilization procedures for sterilization. It is not recommended to sterilize with other sterilization procedures such as ethylene oxide, formaldehyde and low temperature plasma sterilization. The manufacturer assumes no responsibility for the procedures that have not been recommended. If you use the sterilization procedures that have not been recommended, please adhere to related effective standards and verify the suitability and effectiveness.

\*Fractionation pre-vacuum procedure: a procedure for steam sterilization by repeating pre-vacuum, the procedure used here is steam sterilized by three pre-vacuums.

## 6 Maintenance, storage, and transport

### 6.1 Maintenance

#### 6.1.1 Air filter

1) When water accumulates in the filter, turn the knob at the bottom of the filter counterclockwise to drain the water, and tighten the knob clockwise.

2) Replacement of the filter element: Use a filter wrench to unscrew the transparent cover of the air filter, then use the wrench to unscrew the black nut at the lower end of the filter element, remove the white filter element and discard it into the trash can, replace it with a new filter element, and reinstall the black nut and transparent shell. It is recommended to replace the filter element every 24 months, and the spare filter element is included in the accessory.

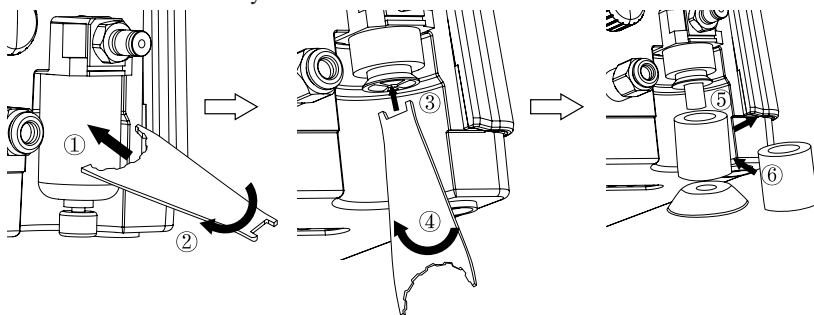

Figure 9 Schematic diagram of filter element replacement

#### 6.1.2 External water filter

Cleaning of the filter: Unscrew the external water connector on the back of the device, take out the disc-shaped filter inside, and use a tweezers to clamp the filter on the outer flame of the alcohol lamp for 5 or 10 seconds (be careful to avoid burns), then use distilled water or pure water to clean. If the external water is used frequently, it is recommended to clean it once a week. It is recommended to clean it every 1-2 months if it is not frequently used.

Replace the filter element every 24 months, and the spare filter element is included in the accessory.

**Note:** The doctor should replace the air filter element and the external water filter piece in strict accordance with the instructions in the manual.

### 6.2 Storage

6.2.1 The device should be handled carefully and lightly. Be sure that it is far from the vibration, and installed or kept in a cool, dry, and ventilated place.

6.2.2 Do not store the machine together with articles that is poisonous, combustible, caustic, or explosive.

6.2.3 This machine should be stored in a room where the relative humidity is 10%~93%, atmospheric pressure is 70kPa~106kPa, and the temperature is

-20°C~+55°C.

6.2.4 When the device is not in use, turn off the power supply and unplug the power plug. If it is not used for a long time, it should be energized and connect to water and air once a month for five minutes.

### 6.3 Transport

6.3.1 Excessive impact and shake should be prevented during transport. Lay it carefully and lightly.

6.3.2 Do not put it together with dangerous goods during transport.

6.3.3 Avoid being exposed to sun, rain, and snow during transport.

## 7 Environmental protection

Part	Toxic or harmful substances or elements					
	Pb	Hg	Cd	Cr6+	PBB	PBDE
Main unit	○	○	○	○	○	○
andpiece	○	○	○	○	○	○
Tip	○	○	○	○	○	○
Nozzle	○	○	○	○	○	○
Foot pedal	○	○	○	○	○	○
Mechanical elements, including bolts, nuts, washers, etc.	○	○	○	○	○	○

○: Indicates that the content of the toxic substance in all homogeneous materials of the part is below the limit requirement stipulated in SJ/T-11363-2006 Limit Requirements for Toxic and Hazardous Substances in Electronic Information Products.

×: indicates that the content of the toxic substance in at least one of the homogeneous materials of the part exceeds the limit requirement specified in SJ/T-11363-2006.

Please dispose according to the local laws or consult with dealer from whom you purchased it about waste disposal.

## 8 After service

We offer one year free repair to the equipment according to the warranty card.

The repair of the equipment should be carried out by professional technician. We are not responsible for any irretrievable damage caused by non-professional person.























This product is a precision equipment. If there is problem that needs to be repaired, returned to Woodpecker or handled by professionals is recommended.

## 9 Manufacturer's right

We reserve the rights to change the design of the equipment, the technique, fittings, the instruction manual and the content of the original packing list at any time without

notice. If there are some differences between blueprint and real equipment, take the real equipment as the norm.

## 10 Symbol instruction

	Trademark		Manufacturer
	Consult the accompanying documents		Date of manufacture
<b>IPX0</b>	Ordinary equipment		B type applied part
	Recovery	<b>IPX1</b>	Anti-drip equipment
	Handle with care		Keep dry
	Alternating current		Used indoors only
	Water volume adjusting switch		Foot pedal
	Water bottle supply		External water supply
	Protective earthing	<b>CE</b> 0197	CE marked product
	Irrigation mode		Anhydrous mode
	Sterilization under high temperature	<b>ON</b> <b>OFF</b>	Power switch
	Water inlet, pressure: 0.1MPa-0.5MPa		
	0.55-0.75MPa Air inlet, pressure: 0.55MPa-0.75MPa		
	Storage condition, air pressure limit: 70kPa ~ 106kPa		
	Storage condition, temperature limit: -20°C ~ +55°C		
	Storage condition, humidity limit: 10% ~ 93%		





Appliance compliance WEEE directive



Authorised Representative in the EUROPEAN COMMUNITY

## 11 European authorized representative

**EC REP** MedNet EC-Rep GmbH  
Borkstrasse 10 · 48163 Muenster · Germany

## 12 EMC-Declaration of conformity

Guidance and manufacturer's declaration of electromagnetic emissions		
The model PT-A is intended for use in the electromagnetic environment specified below. The customer or the user of the model PT-A should assure that it is used in such an environment.		
Emissions test	Compliance	Electromagnetic environment - guidance
RF emissions CISPR 11	Group 1	The model PT-uses RF energy only for its internal function. Therefore, its RF emissions are very low and are not likely to cause any interference in nearby electronic equipment.
RF emissions CISPR 11	Class B	
Harmonic emissions IEC 61000-3-2	Class A	
Voltage fluctuations/ flicker emissions IEC 61000-3-3	Complies	

Guidance & Declaration - electromagnetic immunity			
The model PT-A is intended for use in the electromagnetic environment specified below. The customer or the user of the model PT-A should assure that it is used in such an environment.			
Immunity test	IEC 60601 test level	Compliance level	Electromagnetic environment - guidance
Electrostatic discharge (ESD) IEC 61000-4-2	± 8 kV contact ± 15 kV air	± 8 kV contact ± 15 kV air	Floors should be wood, concrete or ceramic tile. If floors are covered with synthetic material, the relative humidity should be at least 30 %.

Electrical fast transient burst IEC 61000-4-4	± 2kV for power adapter lines ± 1 kV for input output lines	± 2kV for power supply lines ± 1kV for interconnecting cable	Mains power quality should be that of a typical commercial or hospital environment.
Surge IEC 61000-4-5	± 1 kV line to line ± 2 kV line to earth	± 1 kV line to line	Mains power quality should be that of a typical commercial or hospital environment.
Voltage dips, short interruptions and voltage variations on power supply input lines IEC 61000-4-11	<5% UT (>95% dip in UT.) for 0.5 cycle 40% Ur (60% dip in UT) for 5 cycles 70% UT (30% dip in UT) for 25 cycles <5% UT (>95 % dip in UT) for 5 sec	<5% UT (>95% dip in UT .) for 0.5 cycle 40% UT (60% dip in UT for 5 cycles 70% UT (30% dip in UT for 25 cycles <5% UT (>95 % dip in UT) for 5 sec	Mains power quality should be that of a typical commercial or hospital environment If the user of the model PT-A require continued operation during power mains interruptions, it is recommended that the model PT-A be powered from an uninterruptible power adapter or a battery.
Power frequency (50/60 Hz) magnetic field IEC 61000-4-8	3A/m	3A/m	Power frequency magnetic fields should be at levels characteristic of a typical location in a typical commercial or hospital environment.

NOTE Ur is the ac mains voltage prior to application of the test level.

#### Guidance & Declaration - Electromagnetic immunity

The model PT-A is intended for use in the electromagnetic environment specified below. The customer or the user of the model PT-A should assure that it is used in such an environment.

Immunity test	IEC 60601 test level	Compliance level	Electromagnetic environment - guidance
---------------	----------------------	------------------	--

<p>Conducted RF IEC 61000-4-6</p> <p>Radiated RF IEC 61000-4-3</p>	<p>3 Vrms 150 kHz to 80 MHz</p> <p>3V/m 80 MHz to 2.5 GHz</p>	<p>3V</p> <p>3 V/m</p>	<p>Portable and mobile RF communications equipment should be used no closer to any part of the model PT-A, including cables, than the recommended separation distance calculated from the equation applicable to the frequency of the transmitter.</p> <p>Recommended separation distance</p> $d = [3.5/V_1] \times P^{1/2}$ <p><math>d = 1.2 \times P^{1/2}</math> 80 MHz to 800 MHz</p> <p><math>d = 2.3 \times P^{1/2}</math> 800 MHz to 2.5 GHz</p> <p>Where P is the maximum output power rating of the transmitter in watts (W) according to the transmitter manufacturer and d is the recommended separation distance in meters (m).</p> <p>Field strengths from fixed RF transmitters, as determined by an electromagnetic site survey, should be less than the compliance level in each frequency range.</p> <p>a interference may occur in the vicinity of equipment marked with the following symbol:</p> 
--	---	------------------------	--

NOTE 1 At 80 MHz - 800 MHz, the higher frequency range applies.

NOTE 2 These guidelines may not apply in all situations. Electromagnetic propagation is affected by absorption and reflection from structures, objects and people.

A) Field strengths from fixed transmitters, such as base stations for radio (cellular/cordless) telephones and land mobile radios, amateur radio, AM and FM radio broadcast and TV broadcast cannot be predicted theoretically with accuracy. To assess the electromagnetic environment due to fixed RF transmitters, an electromagnetic site survey should be considered. If the measured field strength in the location in which the model PT-A is used exceeds the applicable RF compliance level above, the model PT-A should be observed to verify normal operation. If abnormal performance is observed, additional measures may be necessary, such as reorienting or relocating the model PT-A.

B) Over the frequency range 150 kHz to 80 MHz, field strengths should be less than 3V/m.

Recommended separation distances between portable and mobile RF communications equipment and the model PT-A

The model PT-A is intended for use in electromagnetic environment in which radiated RF disturbances is controlled. The customer or the user of the model PT-A can help prevent electromagnetic interference by maintaining a minimum distance between portable and mobile RF communications equipment (transmitters) and the model PT-A is recommended below, according to the maximum output power of the communications equipment.

Rated maximum output power of transmitter W	Separation distance according to frequency of transmitter m		
	150kHz to 80MHz $d=1.2 \times P^{1/2}$	80MHz to 800MHz $d=1.2 \times P^{1/2}$	800MHz to 0.5GHz $d=2.3 \times P^{1/2}$
0.01	0.12	0.12	0.23
0.1	0.38	0.38	0.73
1	1.2	1.2	2.3
10	3.8	3.8	7.3
100	12	12	23

For transmitters rated at a maximum output power not listed above, the recommended separation distance d in meters (m) can be estimated using the equation applicable to the frequency of the transmitter, where P is the maximum output power rating of the transmitter in watts (W) accordable to the transmitter manufacturer.

NOTE I At 80 MHz - 800 MHz, the separation distance for the higher frequency range applies.

NOTE II These guidelines may not apply in all situations. Electromagnetic propagation is affected by absorption and reflection from structures, objects and people.

The device has been tested and homologated in accordance with EN 60601-1-2 for EMC. This does not guarantee in any way that this device will not be affected by electromagnetic interference Avoid using the device in high electromagnetic environment.

### **13 Statement**

Woodpecker reserves the right to change the design of the equipment, the technique, fittings, instruction manual and the content of the original packing list at any time without further notice. The pictures are only for reference. The final interpretation rights belong to Guilin Woodpecker Medical Instrument Co., Ltd. The appearance of the product was authorized patent, and counterfeit will be sued!

(Please refer to the packaging label for the date of manufacture. Service life: 10 years)

# PT-A Seal replacement Specification Table

Specifications:  $\phi 51 \times \phi 2.1$   
Position: Powder tank



Specifications:  $\phi 5.6 \times \phi 1.2$   
Position: Air filter



Specifications:  $\phi 1.8 \times \phi 1.3$   
Position: Powder tank Base



Specifications:  $\phi 10 \times \phi 1.4$   
Position: Water bottle



Specifications:  $\phi 1.2 \times \phi 1$   
Position: Ultrasonic handpiece tail



Specifications:  $\phi 8 \times \phi 1.5$   
Position: Air polishing handpiece tail



Specifications:  $\phi 3.5 \times \phi 1.5$   
Position: Air polishing handpiece tail



Specifications: Rubber sealing element  
Position: Air polishing handpiece tail



Specifications:  $\phi 4 \times \phi 1$   
Position: Air polishing handpiece



Scan and Login website  
for more information



Guilin Woodpecker Medical Instrument Co., Ltd.  
Information Industrial Park, Guilin National High-Tech  
Zone, Guilin, Guangxi, 541004 P. R. China  
Sales Dept.: +86-773-5873196  
[Http://www.glwoodpecker.com](http://www.glwoodpecker.com)  
E-mail: [woodpecker@glwoodpecker.com](mailto:woodpecker@glwoodpecker.com)



MedNet EC-Rep GmbH  
Borkstrasse 10 · 48163 Muenster · Germany