

SOLUCIONES DENTALES DIGITALES





OPERA[®]
SYSTEM

MÓNACO

Venga a visitarnos
a un lugar excepcional

ARCHIVOS STL ABIERTOS

 Desde escanear una impresión hasta hacer el fresado en sus propias instalaciones, Opera-System ofrece un control absoluto y una libertad total para el FLUJO DE TRABAJO DIGITAL. **AMPLIA GAMA DE MATERIALES DE ALTA CALIDAD - MÁS INFORMACIÓN EN LA PÁGINA 36!**

 De la prise d'empreinte optique à l'usage in-house, Opera-System vous offre l'ouverture absolue et une maîtrise complète de votre FLUX NUMÉRIQUE. **LARGE GAMME DE MATÉRIAUX À DÉCOUVRIR PAGE 36 !**

 Dalla scansione di un'impronta fino alla fresatura, Opera-System offre un controllo totale e completo del FLUSSO DIGITALE. **UNA LARGA GAMMA DI MATERIALI DA SCOPRIRE PAGINA 36 !**



ESCÁNER INTRAORAL
SCAN INTRAORAL
SCAN INTRAORALE | P4



ESCANEAO
NUMÉRISATION
SCANSIONE | P8



DISEÑO
MODÉLISATION
MODELLIZZAZIONE | P12



FRESADO
USINAGE
FABBRICAZIONE | P16



CONSUMIBLE
CONSOMMABLE
CONSUMIBILE | P36



TELÉFONO DE ASISTENCIA

Profesionales cualificados que responderán a todas sus preguntas

SUPPORT HOTLINE DÉDIÉ

Des professionnels qualifiés pour répondre à l'intégralité de vos demandes.

HOTLINE DEDICATA

Professionisti qualificati per rispondere a tutte le vostre richieste.



SESIONES DE FORMACIÓN

Iniciación, descubrimiento, mejora, asistencia remota o presencial que se adapta sus necesidades.

FORMATION

Initiation, découverte, perfectionnement, à distance ou sur site selon vos besoins.

FORMAZIONE

Introduzione, scoperta, formazione, a distanza o sul posto, secondo le vostre esigenze.



ASESORAMIENTO TÉCNICO

Escaneo, diseño, materiales, fresado, solicite nuestras competencias.

EXPERTISE TECHNIQUE

Numérisation, modélisation, matériaux ou usinage, sollicitez nos compétences.

COMPETENZA TECNICA

Digitalizzazione, modellazione, materiali e lavorazione. Richiedete le nostre competenze.



TUTORIALES POR INTERNET - OPERACADEMY

Tutoriales por Internet para ayudarle a dominar las diferentes partes de su sistema CAD/CAM.

TUTORIELS EN LIGNE - OPERACADEMY

Didacticiels en ligne pour vous aider à maîtriser les différentes parties de votre système CFAO.

TUTORIAL ONLINE - OPERACADEMY

Esercitazioni online per formarvi sul vostro sistema CAD /CAM.



DÍAS DE PUERTAS ABIERTAS DE CAD/CAM

Descubra todos nuestros sistemas en un día personalizado dentro de nuestro espacio exclusivo de 1600 m².

OPEN CAD/CAM DAYS

Découvrez l'intégralité de nos systèmes au cours d'une journée personnalisée au sein de notre plateforme de 1600 m².

OPEN CAD/CAM DAYS

Scoprite tutti i nostri sistemi attraverso una giornata personalizzata all'interno del nostro spazio dedicato di 1600 m²

Teléfono de asistencia de Opera-System :



ASISTENCIA POR SKYPE - ID:

**Labs Euromax Monaco .
Clinics Euromax Monaco
Milling Euromax Monaco**

Asistencia a través del software TeamViewer, de lunes a viernes de 09:00 a 12:30 y de 14:00 a 18:00
Prise en main avec le logiciel TeamViewer, du lundi au vendredi de 9h00 à 12h30 et de 14h00 à 18h00
Supporto tramite il software TeamViewer, dal lunedì al venerdì dalle 9:00 alle 12:30 e dalle 14:00 alle 18:00

OPERA MACH2

ESCANER INTRAORAL

GARANTÍA
3
AÑOS

01.

MAYOR RAPIDEZ

Rapidez de escaneo.

Digitalización de una
arcada completa
en 25 segundos
aproximadamente



LUZ ESTRUCTURADA

Reconstitución en 3D a partir
de una nube de puntos extraídos
desde imágenes de video.

NO TOUCH CONTROL

Efecto giroscópico,
navegación sin contacto
en etapas de digitalización.

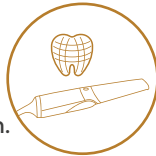

02.

MAYOR PRECISION

Gran profundidad de escaneo que
alcanza hasta 22mm.

Boquillas
adaptadas
para niños
y adultos.



03.

MAYOR EFICACIA

INTELLIGENT SCAN :

Optimización de la digitalización.
Limpieza automática del archivo.

- Pre diseño
- Análisis de recortes
- Detección automática de límites.



OPERA CLOUD

Plataforma interactiva y
conectada entre la clínica
y el laboratorio para un
intercambio y seguimiento
perfecto del caso.

Exportación de
archivos abiertos.

STL - OBJ - PLY



SE INCLUYEN LAS
ACTUALIZACIONES
DEL SOFTWARE !

04.

SOFTWARE INTEGRADO

- Inteligencia artificial
- Modelo virtual (Model builder)
- Análisis Ortho
- Oral health report
(Informe de salud bucal)
- Aplicación móvil « Smart-Preview »

OPTIMIZACIÓN

Con su inteligencia y poderosa
capacidad de procesamiento
de datos, Opera Mach2, ofrece
un uso simple, intuitivo
y confiable.

ERGONOMIA

Puntas autoclavables.
Opera Mach2, más largas
y delgadas, brindan a los pacientes
una experiencia clínica
más cómoda.

EFICACIA

Con una mayor profundidad de escaneo,
Opera Mach2, es ideal para ser usado en
varios escenarios clínicos, incluida la
obtención de scan bodies y exploraciones
periodontales.



Qué es lo que hace que el escáner intraoral OPERA-MACH2 sea exitoso ?

La gran velocidad de digitalización y la mayor precisión potenciada, para una mayor comodidad del paciente y, a su vez, resultados óptimos para el cirujano dental.

Indicaciones diversas :

Desde la práctica general hasta la ortodoncia, el escáner intraoral Opera-Mach2, ofrece una amplia gama de aplicaciones gracias a su alcance, precisión, resolución y « cloud ».

CORONAS



PUENTES



HERRAMIENTA DE DIAGNÓSTICO



INLAYS Y ONLAYS



IMPLANTES



ORTODONCIA



Campo de escaneo

Boquilla estándar : 16 x 12 x 22 mm

Boquilla « niños » : 12 x 9 x 22 mm

Profundidad de escaneo

22mm de la superficie de salida de la boquilla

Tipo de escáner :

Escaneo sin contacto con luz estructurada

Dimensiones

281 mm x 33 mm x 46 mm

Peso

240 ±10g (sin cable)

Formatos de archivo

STL, OBJ, PLY

Conexión

USB 3.0

Alimentación

12 V DC /3 A

CPU

Intel Core i7-8700 ó+

RAM

16 GB ó+

Disco duro :

256 GB SSD ó+

Tarjeta gráfica(GPU)

NVIDIA rtx 2060 6GB DDR3 ó+

Sistema operativo

Windows 10 Professional (64bit) o última versión

Resolución de la pantalla

1920 x 1080 x, 60 Hz ó+

Puertos IN/ OUT

Más de 2 puertos USB 3.0 Tipo-A (ó+)

Versión carro o portátil : Una configuración adaptada a cada necesidad.



Demostración en vivo = 15 min.

1. Una cita por video cuando lo desee. Simplemente escanee el código QR
2. Recibirá un enlace que lo llevará directamente a la presentación.
3. Desde ahí sera guiado, paso a paso, por nuestros tecnicos.



Reserve aquí su demostración personalizada !

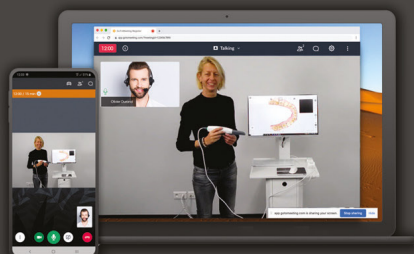

OPERA SYSTEM OS-PRINT

IMPRESORA 3D Y POSTRATAMIENTO ■ IMPRIMANTE 3D & POST-TRAITEMENT ■ STAMPANTE 3D & POST-TRATTAMENTO



ES OS-Print viene con su propio software de control de impresión y planificación de datos optimizado, lo que garantiza un flujo de trabajo intuitivo y fácil de usar. OS-Print ofrece una alta resolución de impresión y una eficiencia excelente. OS-Print se puede aplicar en una amplia variedad de aplicaciones, como modelo de trabajo dental, encerado, guía quirúrgica, encía, bandeja de impresión personalizada, bandeja de transferencia de brackets, etc. **OS-PRINT PUEDE IMPRIMIR 120 CORONAS ENCERADAS EN APROXIMADAMENTE 45 MINUTOS, O 4 MODELOS DE ARCO EN UNA HORA.**

FR OS-PRINT est fournie avec un logiciel de contrôle d'impression et de gestion optimisée des données, ce qui garantit un flux de travail convivial et intuitif. OS-PRINT propose une résolution d'impression élevée et une efficacité exceptionnelle. De nombreuses applications sont possibles : Modèles, calcinables, guides chirurgicaux, masques gingivaux, transfert de brackets, portes-empreintes, etc. **FABRICATION DE 120 COURONNES WAX-UP EN ~45 MIN OU 4 MODÈLES ARCADE COMPLÈTE EN MOINS D'UNE HEURE !**

IT OS-PRINT è fornita con il proprio software ottimizzato di pianificazione e controllo dei dati di stampa, che garantisce un flusso di lavoro intuitivo e facile. Offrendo un'alta risoluzione di stampa e un'eccezionale efficienza, OS-PRINT può essere applicato in una vasta gamma di applicazioni, come: modelli, cerature, guide chirurgiche, gengive, porta impronte personalizzato, **OS-PRINT È IN GRADO DI STAMPARE 120 CORONE WAX UP IN CIRCA 45 MINUTI O 4 ARCADE COMPLETE IN UN'ORA !**

**Volumen de producción
144 x 81 x 180 mm**



PRODUCTIVIDAD
PRODUCTIVITÉ
PRODUTTIVITÀ



AMPLIA VARIEDAD DE APLICACIONES
NOMBREUSES APPLICATIONS
NUMEROSE APPLICAZIONI



WI-FI



ALTA PRECISIÓN
GRANDE PRÉCISION
ALTA PRECISIONE



FUNCIONAMIENTO INTUITIVO
FONCTIONNEMENT INTUITIF
FUNZIONAMENTO INTUITIVO



ABRIR ARCHIVOS STL
FICHIERS STL OUVERTS
FILE STL APERTI



 CARACTERÍSTICAS DE OS-PRINT	 CARACTÉRISTIQUES OS-PRINT	 CARATTERISTICHE OS-PRINT
---	--	---

Dimensiones - Peso 394 x 406 x 755 mm - 30 Kg	Dimensions - Poids 394 x 406 x 755 mm - 30 Kg	Dimensioni - Peso 394 x 406 x 755 mm - 30 Kg
Volumen de impresión (X/Y/Z) 144 x 81 x 180 mm	Volume d'impression (X/Y/Z) 144 x 81 x 180 mm	Volume di stampa (X/Y/Z) 144 x 81 x 180 mm
Velocidad de impresión 40 mm / h*	Rapidité d'impression 40 mm / h*	Velocità di stampa 40 mm / h*
Grosor de la capa 25 µm, 50 µm, 100 µm	Épaisseur de couche 25 µm, 50 µm, 100 µm	Spessore dello strato 25 µm, 50 µm, 100 µm
Resolución nativa DLP 1920 x 1080, 1080p	Résolution native DLP 1920 x 1080, 1080p	Risoluzione nativa DLP 1920 x 1080, 1080p

*La velocidad de impresión varía y está directamente relacionada con los diferentes tipos de material o el grosor de la capa / Variable suivant le matériau ou l'épaisseur / Variabile in base al materiale o allo spessore

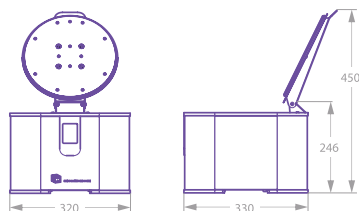

 OS-CURE : Horno para curado con luz led. Polimerización a 360°C ecológica y segura. Programas personalizables.

 OS-CURE : four de photopolymérisation à LED. Polymérisation à 360°C. Écologique et sûr. Programmes personnalisables.

 Forno per fotopolimerizzazione a LED. Polimerizzazione a 360° C. ECOLOGICO E SICURO. PROGRAMMI PERSONALIZZABILI.

 OS-CLEAN: cuba de limpieza con cesto extraíble, 3 programas de lavado y cuba de 4 litros.

 OS-CLEAN : cuve de nettoyage avec panier amovible, 3 programmes de lavage et un réservoir de 4 litres.

 OS-CLEAN: vasca di pulizia con cestello estraibile, 3 programmi di lavaggio e un serbatoio da 4 litri.

 CARACTERÍSTICAS	 CARACTÉRISTIQUES	 CARATTERISTICHE	 CARACTERÍSTICAS	 CARACTÉRISTIQUES	 CARATTERISTICHE
--	--	---	---	--	---

Dimensiones internas 145 x 145 x 120 mm	Dimensions internes 145 x 145 x 120 mm	Dimensioni vano 145 x 145 x 120 mm	Dimensiones internas 145 x 145 x 105 mm	Dimensions internes 145 x 145 x 105 mm	Dimensioni vano 145 x 145 x 105 mm
Tipo de transmisor LED de alta potencia 5W	Type d'émetteur LED haute puissance 5W	Tipo emettitori hi-power LED 5W	Sistema de limpieza Agitador "Contact-Less"	Système de nettoyage Agitateur "Contact-Less"	Sistema lavaggio Agitatore "Contact-Less"
Número de transmisores 24	Nombre d'émetteurs 24	Numero emettitori 24	Modo de limpieza Cesto o plataforma	Mode de lavage Panier ou plate-forme	Modalità lavaggio Cestello o piattaforma
Sistema de radiación Omni-Ray 360°	Système de rayonnement Omni-Ray 360°	Sistema irradiazione Omni-Ray 360°	Capacidad líquida 4 litros máximo	Contenance liquide 4 litres maximum	Capienza liquido: 4 litri al massimo
Potencia total del transmisor 120W	Puissance totale de l'émetteur 120W	Potenza totale emettitori 120W	3 programas Fuerte-medio-delicado	3 Programmes Fort - moyen - délicat	3 Programmi : Forte - medio - delicato
Interfaz Pantalla táctil TFT 2.4"	Interface 2.4" TFT touch screen	Interfaccia 2.4" TFT touch screen	Interfaz Pantalla táctil TFT de 2,4"	Interface 2.4" TFT touch screen	Interfaccia 2.4" TFT touch screen
Conectividad Wifi 2.4 Ghz	Connectivité Wifi 2.4 Ghz	Connettività 2.4 Ghz Wifi	Conectividad Wifi 2.4 Ghz	Connectivité Wifi 2.4 Ghz	Connettività 2.4 Ghz Wifi
Fuente de alimentación 100-230V 2-1.2A 50-60Hz	Tension d'alimentation 100- 2-1.2A 50-60Hz	Tensione di alimentazione 100-230V 2-1.2A 50-60Hz	Fuente de alimentación 100-230V 0.3A 50-60Hz	Tension d'alimentation 100-230V 0.3A 50-60Hz	Tensione di alimentazione 100-230V 0.3A 50-60Hz



 **ALCOHOL ISOPROPILICO 99,9% 1L.- Para limpiar la resina de las impresiones 3D.** El alcohol isopropílico es un buen disolvente de ceras, aceites, resinas y otros productos, pero también es un agente de limpieza (sensores, conectores ópticos, boquillas de impresora), desengrasante y deshidratante.

 **ALCOOL ISOPROPYLIQUE 99.9% 1L - Pour nettoyer vos impressions 3D en résine.** L'alcool isopropylique est un bon solvant pour les cires, les huiles, les résines et de nombreux autres produits, mais aussi un agent de nettoyage (capteurs, connecteurs optiques, buses d'imprimantes), de dégraissage et de déshydratation.

 **Alcool isopropilico 99.9% 1L - Per pulire le tue stampe: resina 3D.** L'alcol isopropilico è un buon solvente per cere, oli, resine e molti altri prodotti, ma anche un detergente (sensori, connettori ottici, ugelli per stampante), sgrassaggio e disidratazione.

OPERA SYSTEM OS-200

ESCÁNER 3D ■ SCANNER 3D ■ SCANNER 3D



Escaneo de arco superior completo en unos 11 segundos

Versión mejorada del OS-100, los escáneres dentales 3D OS-200 añade una velocidad de escaneo excepcional y alta precisión a un escáner ligero y de tamaño compacto. El OS-200 es compatible con múltiples aplicaciones de escaneo dental, incluyendo encerado, pilar, troquel, modelo de yeso, impresión, articulador y textura.

Scan d'une arcade complète en environ 11 secondes !

Le scanner OS-200 conserve les caractéristiques qui font le succès du scanner OS-100. Il propose en outre une vitesse de numérisation exceptionnelle et une grande précision. OS-200 prend en charge de multiples applications de numérisation dentaire, notamment les wax-up, les piliers, les dies, les modèles en plâtre, les empreintes, les articulateurs et les textures.

Scansione del arcata completa in circa 11 secondi

Versione potenziata dell' OS-100 ; il scanner 3D, OS-200, aggiunge ad un formato leggero e compatto una maggiore velocità e alta precisione. OS-200 supporta molteplici applicazioni di scansione dentale, tra cui wax-up, abutment, die, modello in gesso, impronta, articolatore e texture.



“Cabezal inclinable” de escaneo dinámico
Scan dynamique “Tête pivotante”
Scansione dinamica “Testa inclinabile”



RAPIDEZ
RAPIDITÉ
RAPIDITÀ



ESCANEADO DE TEXTURA
SCAN DE TEXTURE
ANALISI DEI TRACCIATI



ALTA PRECISIÓN <10µ
HAUTE PRÉCISION <10µ
ALTA PRECISIONE <10µ



ESCÁNER ARTICULAR
SCAN ARTICULATEUR
SCANSIONE ARTICOLATORE



SOPORTE DE 8 TROQUELES
PLATEAU 8 DIES
SUPPORTO 8 MONCONI





SOPORTE DE IMPRESIONES
SUPPORT D'EMPREINTES
SUPPORTO PER IMPRONTA



ABRIR ARCHIVOS
FICHIERS OUVERTS
FILE APERTI

- **VELOCIDAD DE ESCANEADO MEJORADA:** con una mayor velocidad de escaneo el escaneo de un solo maxilar se puede realizar en aproximadamente 11 segundos.
 - **MEJOR ESCANEADO ARTICULADOR:** un nuevo escaneo dinámico, que puede capturar más del modelo de mandíbula completa para mejorar todavía más la precisión de la oclusión.
 - **NUEVO ESCANEADO TODO EN UNO:** el método de escaneo todo en uno permite escanear modelos de cuadrantes y troqueles al mismo tiempo.
- **VITESSE DE NUMÉRISATION OPTIMISÉE :** le scan d'une arcade complète peut être effectué en ≈11 secondes.
 - **MEILLEURE NUMÉRISATION D'ARTICULATEUR :** nouvelle numérisation dynamique, davantage d'informations de l'arcade complète pour améliorer la précision de l'occlusion.
 - **NOUVEAU SCAN "ALL-IN-ONE" :** la méthode de scan "all-in-one" permet la numérisation de modèles et dies dans un même temps.
- **VELOCITÀ DI SCANSIONE MIGLIORATA :** scansione dell' arcata completa eseguita in ≈11 secondi.
 - **MIGLIORE SCANSIONE DELL'ARTICOLATORE :** una nuova scansione dinamica permette di rilevare maggiori informazioni sull' arcata completa per migliorare la precisione dell'occlusione.
 - **NUOVA SCANSIONE "ALL-IN-ONE" :** il metodo di scansione all-in-one consente la scansione di modelli e monconi contemporaneamente.

 CARACTERÍSTICAS	 CARACTÉRISTIQUES	 CARATTERISTICHE
Resolución 1,3 megapíxeles	Résolution 1,3 mega pixel	Risoluzione 1,3 mega pixel
Precisión <10 micras	Précision <10 microns	Precisione <10 microns
Fuente de luz Luz azul	Source lumineuse Lumière bleue	Fonte di luce Luce blu
Dimensión - Peso 260 mm x 270 mm x 420 mm - 5 kg	Dimension - Poids 260 mm x 270 mm x 420 mm - 5 kg	Dimensioni - Peso 260 mm x 270 mm x 420 mm - 5 kg
Formato de salida STL, OBJ, PLY	Format de sortie STL, OBJ, PLY	Formato uscita STL, OBJ, PLY
Interfaz USB 3.0	Interface USB 3.0	Interfaccia USB 3.0

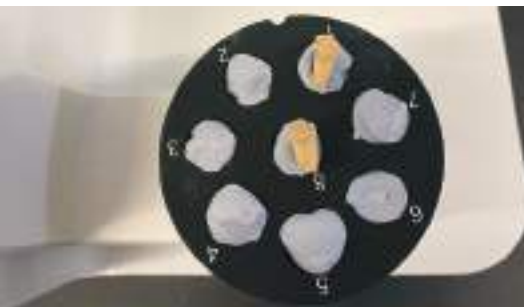

SopORTE de 8 troqueles
Plateau 8 dies
Supporto 8 dies



Permite escanear modelos de cuadrantes y troqueles al mismo tiempo.
All in one: Numérisation de modèles et dies dans un même temps
Scansione di modelli e dies allo stesso tempo



Impresión
Empreinte
Impronta



Articulad
Articulateur
Articolatore



Modelo
Modèle
Modello



Escaneo de textura
Lecture des Textures
Analisi del tracciato



Scan Body



Abutment



Accesorios
Accessoires
Accessori

OPERA SYSTEM ALL BLACK

ESCÁNER 3D ■ SCANNER 3D ■ SCANNER 3D

Detalles ultrafinos ≤ 7 μm
Détails Ultra-fins ≤ 7 μm
Dettagli ultra-fini ≤ 7 μm



PRECISO - ERGONÓMICO - RÁPIDO

Gracias a su diseño abierto y estructura escalable, el escáner 3D All Black ofrece un modo de escaneo de alto rendimiento con una precisión de menos de 7 μm y un escaneo automático de impresión de triple bandeja. all Black es adecuado para todo tipo de restauraciones con implantes, desde las más sencillas hasta las más complejas.

PRÉCIS - ERGONOMIQUE - RAPIDE

Avec son design ouvert et une structure évolutive, le scanner 3D ALL BLACK propose un mode de numérisation hautement performant avec une précision de moins de 7 μm et un scan de l’empreinte Triple-Tray automatique. ALL BLACK est adapté à tous types de restaurations implantaire, des plus simples aux plus complexes.

PRECISO - ERGONOMICO - VELOCE

Con il suo design aperto e la struttura scalabile, lo scanner 3D ALL BLACK offre una modalità di scansione ad alte prestazioni con una precisione inferiore a 7 μm e una scansione automatica dell'impronta a triplo vassoio. ALL BLACK è adatto a tutti i tipi di restauri su impianti, dal più semplice al più complesso.

Paso automático de las fases de escaneo
Passage automatique des étapes de scan
Passaggio automatico delle fasi di scansione



DETALLES ULTRAFINOS
 DÉTAILS ULTRA-FINS
 DETTAGLI ULTRA-FINI



RAPIDEZ
 RAPIDITÉ
 VELOCITÀ



ALTA PRECISIÓN <7μ
 HAUTE PRÉCISION <7μ
 ALTA PRECISIONE <7μ



ESCANEO DE TEXTURA
 SCAN DE TEXTURE
 ANALISI DEI TRACCIATI



ESCANEO DINÁMICO
 SCAN DYNAMIQUE
 SCANSIONE DINAMICA



SOPORTE DE 8 TROQUELES
 PLATEAU 8 DIES
 SUPPORTO 8 DIES



IMPRESIÓN AUTOMÁTICA
 EMPREINTE AUTOMATIQUE
 IMPRESSIONE AUTOMATICA



ARCHIVOS STL
 FICHIERS STL OUVERTS
 FILE STL APERTI

**CARACTERÍSTICAS**

Dimensión
240 mm x 340 mm x 450 mm

Peso
~ 7,5 kg

Resolución de la cámara
2 x 5.0 MP

Precisión
≤ 7 μm (ISO 12836)

Tiempo de escaneo
Escaneo de la mordida : < 6s
Escaneo de la mandíbula superior/inferior:<13s
1-4 dies : <18s / 5-8 dies : < 33s
impresiones : < 32s

Escaneo del articulador - Dinámica estática;
transferencia de articulador de soporte

Formato de archivo STL, PLY - Integración
directa Exocad - Dental Wings - 3 Shape

Fuente de luz
Luz azul

Fuente de alimentación
DC24V (220 V)

**CARACTÉRISTIQUES**

Dimension
240 mm x 340 mm x 450 mm

Poids
~ 7,5 kg

Résolution des caméras
2 x 5.0 MP

Précision
≤ 7 μm (ISO 12836)

Rapidité de scan
Modèle : < 6s
Modèle en occlusion : <13s
1-4 dies : <18s / 5-8 dies : < 33s
Empreinte : < 32s

Scan articulateur - Dynamique / statique ;
support de transfert d'articulateur

Format de fichiers STL, PLY Intégration directe
Exocad - Dental Wings - 3 Shape

Source de lumière
Lumière structurée bleue

Alimentation
DC24V (220 V)

**CARATTERISTICHE**

Dimensioni
240 mm x 340 mm x 450 mm

Peso
~ 7,5 kg

Risoluzione camera
2 x 5.0 MP

Precisione
≤ 7 μm (ISO 12836)

Tempo di scansione
Scansione bite : < 6s
Scansione mascella superiore/inferiore; : <13s
1-4 dies : <18s / 5-8 dies : < 33s
Scansione impronta : < 32s

Scansione Articolatore - Dinamica / Statica;
supporta il trasferimento articolatore

Formato Output STL, PLY Integrazione diretta
Exocad - Dental Wings - 3 Shape

Sorgente Luce
Luce Blu

Alimentazione
DC24V (220 V)



Soporte de 8 troqueles
Plateau 8 dies
Supporto 8 dies



Scansione All-in-one
All-in-one



Pilar
Abutment



Soporte de Impresión
Support d'empreintes
Porta impronta



Articulador - Escaneo estático
Articulateur - Scan statique
Articolatore - Scansione statica



Articulador - Escaneo dinámico
Articulateur - Scan dynamique
Articolatore - Scansione dinamica

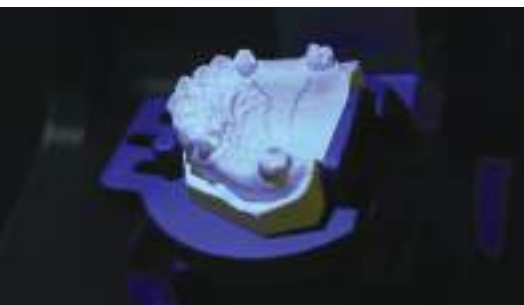

Escaneo de textura
Lecture des Textures
Analisi del tracciato



Scan Body



Modelo
Modèle
Modello



OS-CAD BY exocad CORONAS Y PUENTES - COURONNE & BRIDGE - CORONE & PONTI



Coronas anatómicas
Couronnes anatomiques • Corona anatomica



Elementos anatómicossencillos
Chapes simples et anatomiques • Cappetta semplice e anatomica



Uniones
Attachements • Attacchi



Marco de puente
Structure de bridge • Struttura del ponte

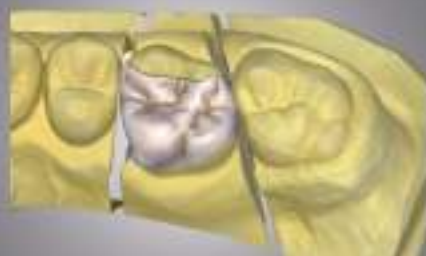

Empastes / recubrimientos
Inlays/onlays • Inlays/onlays



Carillas
Facettes • Facette



Procedimientos con encerados
Wax-up • Ceratura



Coronas telescópicas
Couronnes télescopiques • Corona telescopica



Diagnóstico
Diagnosticque • Diagnostica



OS-CAD by exocad MÓDULO DE IMPLANTES - MODULE IMPLANT - GESTIONE DELL'IMPIANTO



Puente de implante con encía
Bridge Implantaire avec gencive • Ponti implantari con gengive



Puente de implante
Bridge sur pilier • Ponte su abutment



Puente sobre implantes
Bridge implantaire • Ponte avvitato su impianti



Pilar personalizado
Pilier personnalisé • Pilastrì personalizzati



Pilar personalizado
Pilier personnalisé • Pilastrì personalizzati



Viewer Web



Puentes con retención por tornillos
Bridges transvisés • Ponti avvitati



Pilares y superestructuras
Piliers et suprastructures personnalisés • Pilastrì e sovrastrutture personalizzate



Canales de tornillos
Trou de vis angulé • Angolatura canale della vite



OS-CAD by exocad MÓDULO DE BARRA - MODULE BARRE - MODULO BARRE IMPLANTARI



Barras de retención
Barre avec rétenions • Barre con ritenzioni



Barras de unión
Barre avec attachements • Barre con attacchi



Barra de implante
Barre implantaire réduite • Barra implantare



OS-CAD by exocad CREADOR DE MODELOS - MODEL CREATOR



Creación de modelos en bandeja digital
Créer des modèles physiques d'après des numérisations d'empreintes dentaires
Creazione di modelli su base impronta numerica



Modelo de implante
Modèle Implant
Modello implantare



Diferentes modelos/estilos de troqueles disponibles
Différents modèles/dies disponibles
Diversi modelli/monconi disponibili



OS-CAD by exocad MÓDULO DE FÉRULA DE MORDIDA - MODULE GOUTTIÈRE - MODULO MASCHERINE



Cálculo de la férula
Calcul de la gouttière • Calcolo delle mascherine



Adaptar la férula al antagonista
Adapter les gouttières à l'antagoniste • Adattare le mascherine all' antagonista



Resultado final listo para la producción
Résultat final prêt pour la production • Risultato finale pronto ad essere prodotto



OS-CAD by exocad MÓDULO PROVISIONAL - MODULE PROVISOIRE - MODULO PROVVISORIO



Puente provisional aconchado
Bridge provisoire coquille • Corona provvisoria conchiglia



Puente provisional aconchado
Bridge provisoire coquille • Corona provvisoria conchiglia



Puente provisional aconchado
Bridge provisoire coquille • Corona provvisoria conchiglia



OS-CAD by exocad MARCOS PARCIALES - PROTHÈSE PARTIELLE - PROTESI PARZIALE AMOVIBILE



Marco de arco superior
Sous-structure • Sottostruttura



Encerado virtual sin pilar
Wax-up virtuel sans pilier • Tooth chain con occlusione



Corona telescópica
Couronne télescopique sur selle • Corona telescopica



OS-CAD by exocad DENTADURA POSTIZA - MODULE POUR PROTHÈSES COMPLÈTES - PROTESI COMPLETA



Alvéolos
Logette • Alveole



Posicionamiento de los dientes
Positionnement des dents • Posizione dei denti



Diseño digital de dentaduras postizas completas
Prothèse complète • Protesi completa



OS-CAD by exocad ARTICULATEUR VIRTUEL - ARTICULADOR VIRTUAL - ARTICOLATORE VIRTUALE



Occlusion with the virtual articulator • Occlusion avec l'articulateur virtuel • Validazione dell'occlusione con l'articolatore virtuale



OS-CAD BY EXOCAD IMPORTACIÓN DEL MOVIMIENTO DE LA MANDÍBULA - IMPORT DE MOUVEMENTS DE LA MÂCHOIRE - IMPORTAZIONE MOVIMENTO DELLA MANDIBOLA

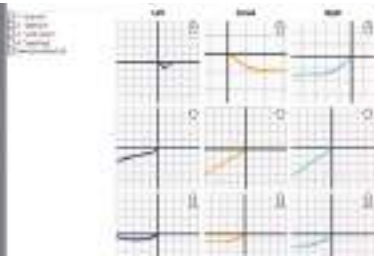

Transferencia de movimientos dinámicos de la mandíbula del paciente
 Transfert des mouvements dynamiques de la mâchoire du patient
 Trasferimento di movimenti dinamici della mascella del paziente

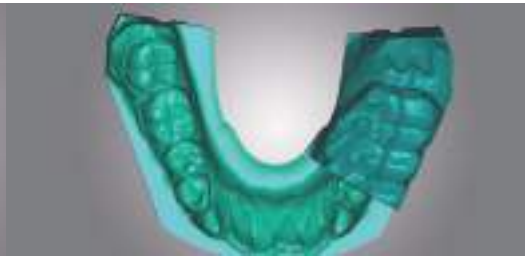

Creación de modelos físicos semidinámicos innovadores (módulo Creador de modelos)
 Créer des modèles physiques semi-dynamiques innovants (module Model Creator)
 Creare modelli fisici semi-dinamici innovativi (modulo Model Creator)



Importación del movimiento de la mandíbula
 Import de mouvements de la mâchoire
 importazione movimento della mandibola



OS-CAD BY EXOCAD
SMILE DESIGN



OS-CAD BY EXOCAD
DICOM VIEWER



OS-CAD BY EXOCAD
TRUSMILE



Diseño de sonrisa de próxima generación: 2D y 3D, lo mejor de ambos mundos
 Conception de sourire nouvelle génération: 2D et 3D, le meilleur des deux mondes
 Disegno del sorriso di nuova generazione: 2D e 3D, il meglio dei due mondi



Visualización de datos TC durante el proceso de diseño
 Visualiser les données CT pendant le processus de conception
 Visualizzazione dei dati CT durante il processo di progettazione



Representación realista de restauraciones dentales
 Rendu réaliste des restaurations dentaires
 Rappresentazione realistica di restauri dentali



OS-CAD BY EXOCAD
BIBLIOTECA DENTAL



OS-CAD BY EXOCAD
ORTODONCIA - ORTHODONTIE - ORTODONZIA



Varias bibliotecas de anatomía
 Bibliothèques d'anatomie • Librerie anatomiche



Segmentación de dientes con un solo clic
 Segmentation des dents en un clic • Segmentazione dei denti in un clic



Archivo de ortodoncia
 Archivage orthodontique • Archiviazione Ortodontica



OS-CAD EXOPLAN BY EXOCAD CIRUGÍA DIRIGIDA - CHIRURGIE GUIDÉE - CHIRURGIA GUIDATA

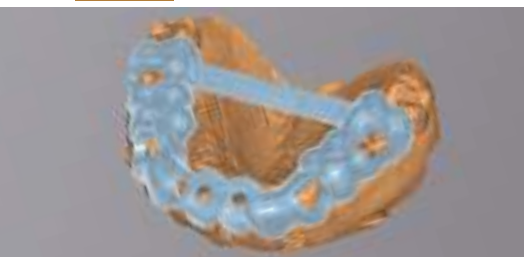

Guías quirúrgicas internas con módulo Guide Creator
 Des guides chirurgicaux en interne avec le module Guide Creator
 Guide chirurgiche in-house con il modulo Guide Creator



Máxima precisión: alineación de los datos escaneados
 Précision maximale - alignement des données de scan
 Massima precisione - allineamento dei dati di scansione



Biblioteca completa de implantes y componentes
 Une vaste bibliothèque d'implants et de composants
 Libreria completa di impianti e componenti



OS-CAD BY EXOCAD CHAIRSIDE



Potente software de CAD dental para utilizarlo en un entorno clínico
 Logiciel de CAO dentaire performant pour une utilisation au cabinet
 Potentare software dentale CAD per cliniche odontoiatriche



Amplia gama de indicaciones para tratamientos en una sola visita
 Une vaste gamme d'indications pour les traitements en une seule séance
 Ampia gamma di indicazioni per i trattamenti in una singola visita



Optimizado para ser utilizado en un entorno clínico
 Utilisation optimisée pour une utilisation dans un environnement clinique
 L'utilizzo ottimizzato per un utilizzo in una clinique ambientale

OPERA SYSTEM FRESADO

MÁQUINAS DE FRESADO ■ MACHINES À USINER ■ FABBRICAZIONE



Fresado en seco y húmedo ... Discos o bloques.

OPERA SYSTEM ofrece la máquina adecuada para cada aplicación. Con acceso directo al CAD/CAM digital, agilizará el nivel de productividad de su laboratorio. La solución CAD/CAM de OperaSystemle ofrece una oportunidad decisiva para trabajar con materiales nuevos como la circonita UT-ML o ST-ML. La calidad de una solución digital certificada accesible a todo el mundo

Usinage à sec ou sous eau... Disques et/ou blocs.

OPERA SYSTEM vous propose une large gamme de solutions d'usinage pour des besoins différents, et vous ouvre des opportunités de développement sur des matériaux d'exceptions comme les zircons Opera Viva multi-couches.

Lavorazione a secco o a umido... Lavorazione di blocchi o dischi.

OPERA SYSTEM offre una vasta gamma di soluzioni di lavorazione per esigenze diverse e offre opportunità di sviluppo per materiali eccezionali come l'ossido di zirconio multistrato Opera Viva.



OPERA SYSTEM DENTAL CAM

MILLING SOFTWARE ■ LOGICIEL D'USINAGE ■ PROGRAMMI DI FRESAGGIO



ES Nuevo software, nuevas características... Producción optimizada. Descubra las numerosas funciones de la CAM dental compatibles con la solución de fresado de Opera System... **El software de CAM que se facilita incluye todas las estrategias de fresado.**

FR Nouveau logiciel, Nouvelles fonctionnalités... Une production optimisée. Découvrez les nombreuses fonctionnalités du Dental CAM compatible avec votre solution d'usinage opera system... **Logiciel CAM fourni avec des stratégies d'usage spécialement adaptées.**

IT Nuovo software, nuove funzionalità ... una produzione ottimizzata. Scoprite le numerose funzionalità del Dental CAM compatibili con le fresatrici Opera System... **Software CAM fornito con le strategie di lavorazione adattate.**

CORTADORAS - OUTILS DE FRAISAGE - FRESE :

1 Universal - 0,3 mm	5 axes	U030-R2-40	18 Zircon Traité - 1 mm	5 axes	Z100-R2-40	35 Composites Diamanté - 1 mm	4 axes	C100-R1D-35
2 Universal plate - 0,5 mm	5 axes	U050-F2-40	19 Zircon Traité - 2 mm	5 axes	Z200-R3-40	36 Composites Diamanté - 2 mm	4 axes	C200-R1D-35
3 Universal - 0,6 mm	5 axes	U060-R2-40				37 Zircon Traité - 1 mm	4 axes	Z100-R2-35
4 Universal plate - 1,2 mm	5 axes	U120-F2-40	20 Metal CoCr - 0,6 mm	5 axes	M060-R2-35	38 Zircon Traité - 2 mm	4 axes	Z200-R3-35
			21 Metal CoCr - 1 mm	5 axes	M100-R2-35			
5 WAX PMMA - 1 mm	5 axes	P100-R2-40	22 Metal CoCr - 1,2 mm	5 axes	M120-T2-35	39 Zircon Diamanté - 0,6 mm	4 axes	Z060-R2D-35
6 WAX PMMA - 2 mm	5 axes	P200-R2-40	23 Metal CoCr - 2 mm - 4 cuts	5 axes	M200-R4-35	40 Zircon Diamanté - 1 mm	4 axes	Z100-R2D-35
7 WAX PMMA - 2,5 mm	5 axes	P250-F1-40				41 Zircon Diamanté - 1,2 mm	4 axes	Z120-F2D-35
8 WAX PMMA - 1 mm - 1 cut	5 axes	P100-R1-40	24 Universel - 0,3 mm	4 axes	U030-R2-35	42 Zircon Diamanté - 2 mm	4 axes	Z200-R3D-35
9 WAX PMMA - 2 mm - 1 cut	5 axes	P200-R1-40	25 Universel plate - 0,5 mm	4 axes	U050-F2-35			
			26 Universel - 0,6 mm	4 axes	U060-R2-35	43 Vitrocéramique - 0,6 mm	4 axes	G060-R-35
10 Composites - 1 mm	5 axes	C100-R2-40	27 Universel plate - 1,2 mm	4 axes	U120-F2-35	44 Vitrocéramique - 1 mm	4 axes	G100-R-35
11 Composites - 2 mm	5 axes	C200-R2-40				45 Vitrocéramique - 2,6 mm	4 axes	G260-T-35*
			28 WAX PMMA - 1 mm	4 axes	P100-R2-35	46 Vitrocéramique - 2,4 mm	4 axes	G240-R35*
12 Composites Diamanté - 1 mm	5 axes	C100-R1D-40	29 WAX PMMA - 2 mm	4 axes	P200-R2-35	47 Vitrocéramique plate - 1,2 mm	4 axes	G120-T-35
13 Composites Diamanté - 2 mm	5 axes	C200-R1D-40	30 WAX PMMA - 2,5 mm	4 axes	P250-F1-35			
			31 WAX PMMA - 1 mm - 1 cut	4 axes	P100-R1-35	48 Metal CoCr - 0,6 mm	4 axes	M060-R2-32
14 Zircon Diamanté - 0,6 mm	5 axes	Z060-R2D-40	32 WAX PMMA - 2 mm - 1 cut	4 axes	P200-R1-35	49 Metal CoCr - 1 mm	4 axes	M100-R2-32
15 Zircon Diamanté - 1 mm	5 axes	Z100-R2D-40				50 Metal CoCr - 1,2 mm	4 axes	M120-T2-32
16 Zircon Diamanté - 1,2 mm	5 axes	Z120-F2D-40	33 Composites - 1 mm	4 axes	C100-R2-35	51 Metal CoCr - 2 mm	4 axes	M200-R2-32
17 Zircon Diamanté - 2 mm	5 axes	Z200-R3D-40	34 Composites - 2 mm	4 axes	C200-R2-35	52 Metal CoCr - 2 mm - 4 cuts	4 axes	M200-R4-32

ES Permite el fresado: PMMA-Wax (K), Zirconio tratado (Z), Composite (C)
 Exclusivo para mecanizado en húmedo: 35-36-37-38-39-40 (26-27-28-29-30 se puede utilizar para mecanizado en húmedo o seco)
 *Las cortadoras G260-T-35 son adecuadas para usuarios de la versión CAM anterior a 7.0 / para la nueva versión 7.0 de la CAM utilice las cortadoras G240-R35

FR Universel Permet d'usiner : PMMA-Wax (K), Zirconio traité (Z), Composite (C)
 Exclusivement pour l'usinage humide : 35-36-37-38-39-40 (les 26-27-28-29-30 peuvent être utilisées pour l'usinage humide et/ou sec)
 *Les fraises G260-T-35 conviennent aux utilisateurs de la version CAM antérieure à 7.0 / pour la nouvelle version CAM 7.0 utiliser les fraises G240-R35

IT Permette una lavorazione: PMMA-Wax (K), zirconio trattato (Z), Composito (C)
 Esclusivamente per la lavorazione a umido: 35-36-37-38-39-40 (26-27-28-29-30 possono essere utilizzati per lavorazioni a umido e / o a secco)
 *le frese sono adatte per gli utenti della versione CAM precedenti alla 7.0 / per la nuova versione CAM 7.0 utilizzano i cutter G240-R35

OPERA SYSTEM ARKO

4 EJES & FRESADO HÚMEDO ■ USINAGE 4 AXES & SOUS EAU ■ 4 ASSI & LAVORAZIONE UMIDO



Rápido y preciso: restauraciones en menos de 10 minutos. Compresor integrado

Fresado y pulido en ultra-HD. funcionamiento fácil e intuitivo: montaje con 1 clic: montaje de material sin herramientas. Inserción de bloques en 2 segundos. Muy silencioso debido al aislamiento interno y la carcasa de material fundido.

Usinage rapide et précis : Restaurations en moins de 10 minutes ! Compresseur intégré !

Fraisage et meulage ultra-HD. Fonctionnement facile et intuitif : Montage en 1 clic : serrage de bloc automatique, en 1 clic. Solution silencieuse et confortable : Etanchéité et isolation phonique. Armature en aluminium coulé pour une meilleure assise et stabilité.

Veloce e preciso: restauri in meno di 10 minuti ! Compressore integrato !

Fresatura in ultra-HD. Funzionamento facile e intuitivo: montaggio con 1 clic: montaggio del materiale senza attrezzi. Soluzione silenziosa: impermeabilità e insonorizzazione. Telaio in fusione di alluminio per una migliore stabilità.

4 EJES
4 AXES
4 ASSI



6 HERRAMIENTAS
6 OUTILS
6 UTENSILI



PREFRESADO
PILIER PERSONNALISÉ
ABUTMENT PERSONALIZZATO



HÚMEDO
HUMIDE
UMIDO



WEBCAM INTEGRADA
WEBCAM INTÉGRÉE
WEBCAM INTEGRATA





PANTALLA TÁCTIL
ECRAN TACTILE



PLUG
& PLAY

Compressore integrato !
Compresor integrado !
Compresseur intégré !

 CARACTERÍSTICAS	 CARACTÉRISTIQUES	 CARATTERISTICHE
Tamaño (ancho x profundo x alto) 471 x 522 x 507 mm	Dimensions (L x P x H) 471 x 522 x 507 mm	Dimensioni (L x P x H) 471 x 522 x 507 mm
Peso ~ 66 kg	Poids ~ 66 kg	Peso ~ 66 kg
Número de ejes 4	Nombre d'axes simultanés 4	Numero d'assi 4
Precisión en repeticiones 3 micras	Précision de répétabilité 3 microns	Precisione di ripetizione 3 microns
Husillo asincrónico SFZ 170PP Husillo girando hasta 100 000 RPM	Broche asynchrone SFZ 170P Vitesse de rotation 100 000 tours / minute	Mandrino asincrono SFZ 170P Velocità fino a 100.000 rpm
Cambiador automático de herramientas 6 herramientas	Changeur d'outil automatique 6 outils	Caricatore automatico 6 utensili
Webcam integrada Para controlar el procesamiento	Webcam intégrée Pour contrôle d'usinage	Webcam integrata Per il controllo della lavorazione
Compresor integrado No se necesita compresor	Compresseur intégré Aucun compresseur nécessaire	Compressore integrato Nessun compressore necessario
Funcionamiento fácil e intuitivo Pantalla táctil inteligente, cajón automático, PC integrado	Fonctionnement intuitif Ecran tactile, porte automatique, PC intégré	Funzionamento facile e intuitivo Smart touchscreen, cassetto automatico, PC integrato
Fácil inserción del bloque Montaje con 1 clic: montaje de material sin herramientas.	Montage du bloc facile En 1 clic : serrage de bloc automatique	Facile inserimento del blocco Montaggio con 1 clic: montaggio del materiale senza attrezzi.
Agua destilada No se necesitan aditivos.	Eau claire Aucun additif nécessaire.	Acqua distillata Non sono necessari additivi.

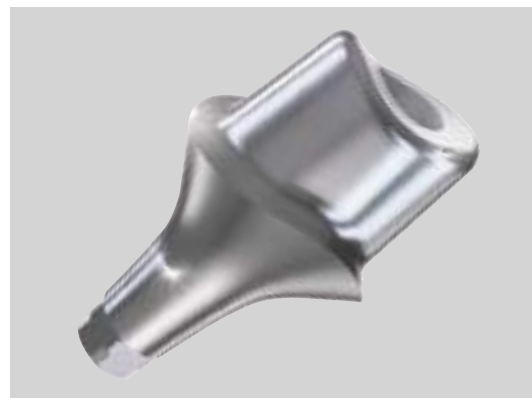
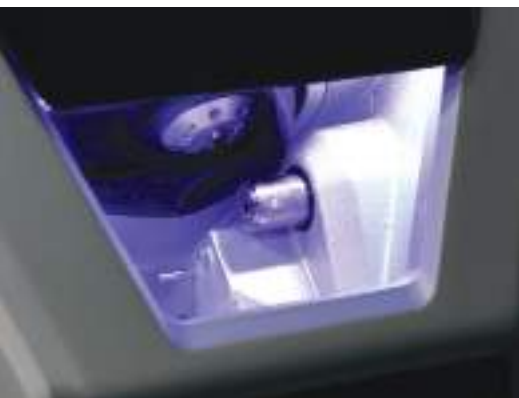

OPERA SYSTEM PREMIUM+

4 EJES Y FRESADO HÚMEDO ■ USINAGE 4 AXES & SOUS EAU ■ 4 ASSI & LAVORAZIONE UMIDO





 Premium+ es una máquina amoldadora húmeda compacta de cuatro ejes sin una unidad externa para amoldar, que se puede usar con bloques de fresado de cerámica de vidrio, óxido de circonio y compuestos, así como pilares de titanio. Intercambio manual de piezas de trabajo. **Sistema de líquido refrigerante integrado (bomba y filtro incluidos): no se necesita aspirar..**

 La Premium+ offre une solution d'usinage compacte sous eau permettant le meulage de blocs vitro-céramiques et autres matériaux composites. Changement manuel des blocs. **Circuit de refroidissement intégré avec pompe et filtre - Pas d'aspiration nécessaire.**

 Premium + offre una soluzione quattro assi compatta per la lavorazione ad umido di blocchi in vetroceramica e altri materiali compositi. Caricamento manuale dei blocchi. **Circuito di raffreddamento integrato con pompa e filtro - Aspirazione non necessaria.**

- 4 EJES
4 AXES
4 ASSI 
- 3 BLOQUES
3 BLOCS
3 BLOCCHI 
- 8 HERRAMIENTAS
8 OUTILS
8 UTENSILI 
- HÚMEDO
HUMIDE
UMIDO 
- CERÁMICA DE VIDRIO
VITRO CÉRAMIQUE
VETROCERAMICA 
- PREFRESADO
PILIER PERSONNALISÉ
ABUTMENT PERSONALIZZATO 
- WEBCAM INTEGRADA
WEBCAM INTÉGRÉE
WEBCAM INTEGRATA 



 CARACTERÍSTICAS	 CARACTÉRISTIQUES	 CARATTERISTICHE
Tamaño (ancho x profundo x alto) 360 x 451 x 471 mm	Dimensions (L x P x H) 360 x 451 x 471 mm	Dimensioni (L x P x H) 360 x 451 x 471 mm
Peso ~ 50 kg	Poids ~ 50 kg	Peso ~ 50 kg
Número de ejes 4	Nombre d'axes simultanés 4	Numero d'assi 4
Precisión en repeticiones ±3 microns	Précision de répétabilité ±3 microns	Precisione di ripetizione ±3 microns
Husillo síncrono SFN 300 P Velocidad de rotación Hasta 80 000 RPM Potencia nominal 300 W - Potencia de salida máxima 800W	Broche synchrone SFN 300 P Vitesse de rotation Jusqu'à 80 000 tours/minute P. nominale 300 W - P. utile maximale 800 W	Mandrino síncrono SFN 300 P Velocità di rotazione Fino a 80 000 giri / minuto P. nominale 300 W - P utile massima 800 W
Cambiador automático de herramientas 8 herramientas	Changeur d'outil automatique 8 outils	Caricatore automatico 8 utensili
Rango de posicionamiento XYZ 80 X 60 X 40 mm	Mouvement des axes XYZ 80 X 60 X 40 mm	Movimenti assi 80 X 60 X 40 mm
Consumo de aire seco comprimido Aprox. 35 l/min a 4 bares	Consommation d'air sec comprimé Env. 35 l/min à 4 bars	Consumo d'aria compressa Circa 35 l/min à 4 bars



OPERA SYSTEM **EASY4 EDITION**

4 EJES & FRESADO SECO ■ USINAGE 4 AXES & À SEC ■ 4 ASSI & LAVORAZIONE A SECCO



Easy 4 es una máquina de alta precisión, muy económica y fiable.

Lo más llamativo es el diseño extremadamente compacto de Easy 4. Tras un examen más detallado, su construcción rígida salta a la vista. Por lo que garantiza unos resultados óptimos, incluso con aleaciones no preciosas muy duras sobre una base de cobalto-cromo. **Espesor de discos de 10 mm a 25 mm - Ø 98 mm**



La Easy 4 est une machine à usiner haute précision compacte, très abordable et fiable.

Le modèle Easy 4 vous assure des résultats de première qualité, même dans les cas d'usinages extrêmement durs d'alliages non-précieux sur une base de chrome-cobalt. La haute qualité de l'entraînement et des unités de mesure assurent la production d'usinages parfaits. **Épaisseur de disques de 10 à 25 mm - Ø 98 mm**

Easy 4 è una macchina di alta precisione compatta, molto economica e affidabile.

Con un design compatto, il modello Easy 4 garantisce risultati di alta qualità, anche nel caso di lavorazioni estremamente difficili di leghe non preziose su base di cromo-cobalto. **Spessore dei dischi da 10 a 25 mm - Ø 98 mm**



 CARACTERÍSTICAS	 CARACTÉRISTIQUES	 CARATTERISTICHE
Tamaño (ancho x profundo x alto) 400 x 385 x 410 mm	Dimensions (L x P x H) 400 x 385 x 410 mm	Dimensioni (L x P x H) 400 x 385 x 410 mm
Peso ~ 45 kg	Poids ~ 45 kg	Peso ~ 45 kg
Número de ejes 4	Nombre d'axes simultanés 4	Numero d'assi 4
Precisión en repeticiones ± 5 microns	Précision de répétabilité ± 5 microns	Precisione di ripetizione ± 5 microns
Husillo asincrónico SF 170 Velocidad de rotación Hasta 60 000 RPM Potencia nominal 170 W - Potencia de salida máxima 240W	Broche asynchrone SF 170 Vitesse de rotation Jusqu'à 60 000 tours/minute P. nominale 170 W - P. utile maximale 240 W	Mandrino Asincrono SF 170 Con velocità di rotazione Fino a 60 000 giri / minuto P. nominale 170 W – P utile massima 240 W
Cambiador automático de herramientas 7 herramientas	Changeur d'outil automatique 7 outils	Caricatore automatico 7 utensili
Rango de posicionamiento XYZ 100 x 98 x 40 mm	Mouvement des axes XYZ 100 x 98 x 40 mm	Movimenti assi 100 x 98 x 40 mm
Consumo de aire seco comprimido Aprox. 80 l/min a 7 bares	Consommation d'air sec comprimé Env. 80 l/min à 7 bars	Consumo d'aria compressa Circa 80 l/min à 7 bars

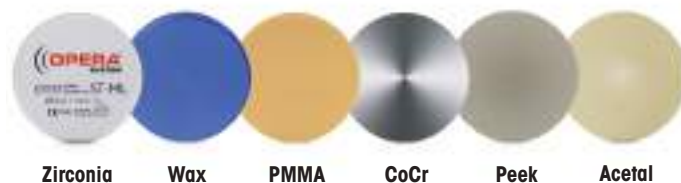
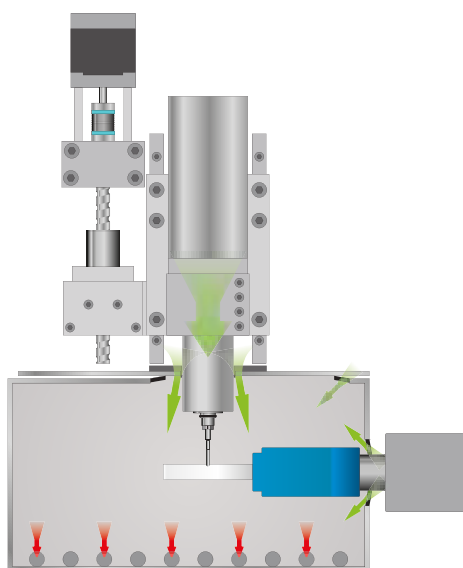

 Cámara de trabajo protegida e integrada: Alta protección contra el polvo - Espacio de trabajo seguro – Luz en la cámara de trabajo.

 Cabine de travail étanche : Excellente protection à la poussière - Espace de travail sécurisé - Eclairage de l'aire de travail.

 Cabina di lavorazione ermetica : Grande resistenza alla polvere - Spazio di lavorazione sicuro - Illuminazione dello spazio di lavoro.

OPERA SYSTEM EASY 5+

5 EJES & FRESADO SECO ■ USINAGE 5 AXES & À SEC ■ 5 ASSI & LAVORAZIONE A SECCO



Tecnología Disc Direct para asegurar discos: gracias a este sistema de sujeción de los discos sin herramientas, la máquina se puede cargar con material de manera más rápida y sencilla. **Ionizador incorporado:** neutraliza la carga estática de partículas acrílicas. Gracias a la circulación de aire mejorada en el área de trabajo, el tiempo de limpieza se reduce de forma significativa.

Technologie Direct Disc - serrage des disques sans outils : Grâce à ce système de serrage des disques sans outil, la machine peut être chargée rapidement et facilement. **Ioniseur intégré :** neutralise la charge statique des particules acryliques. La circulation d'air dans la zone de travail permet un nettoyage facile et rapide.

Tecnologia Direct Disc - serraggio dischi senza attrezzi : grazie a questo sistema di bloccaggio del disco senza attrezzi, la fresatrice può essere caricata rapidamente e facilmente. **Ionizzatore integrato:** neutralizza la carica statica delle particelle acriliche. La circolazione dell'aria nell'area di lavoro consente una pulizia facile e veloce.

5 EJES
5 AXES
5 ASSI



SISTEMA DE SUJECCIÓN DE LOS DISCOS
SIN HERRAMIENTAS
SERRAGE AUTOMATIQUE DES DISQUES
BLOCCAGGIO DEL DISCO SENZA ATTREZZI

SECO
SEC
A SECCO



OPCIÓN 3 BLOQUES SECOS
OPTION 3 BLOCS À SEC
OPZIONE 3 BLOCCHI A SECCO

CoCr





IONIZADOR INTEGRADO
IONISEUR INTÉGRÉ
IONIZZATORE INTEGRATO

16 HERRAMIENTAS
16 OUTILS
16 UTENSILI



WEBCAM INTEGRADA
WEBCAM INTÉGRÉE
WEBCAM INTEGRATE



 CARACTERÍSTICAS	 CARACTÉRISTIQUES	 CARATTERISTICHE
Tamaño (ancho x profundo x alto) 450 x 545 x 630 mm	Dimensions (L x P x H) 450 x 545 x 630 mm	Dimensioni (L x P x H) 450 x 545 x 630 mm
Peso ~ 91 kg	Poids ~ 91 kg	Peso ~ 91 kg
Número de ejes 5 ejes: 3 ejes lineales y 2 ejes rotativos (A y B)	Nombre d'axes simultanés 5 axes : 3 axes linéaires et 2 axes rotatifs (A et B)	Numero d'assi 5 assi : 3 assi lineari e 2 assi rotanti (A e B)
Precisión en repeticiones ± 3 micras	Précision de répétabilité ± 3 microns	Precisione di ripetizione ± 3 microns
Husillo Husillo sincrono SFK 300 P - Potencia nominal 300 W - Potencia de salida máxima 500W	Broche Mandrín sincrone SFK 300P P. nominale 300 W - P. utile maximale 500 W	Mandrino Mandrino sincrono SFK 300P P. nominale 300 W - P. utile massima 500 W
Velocidad de rotación Hasta 60 000 RPM	Vitesse de rotation Jusqu'à 60 000 tours/minute	Velocità di rotazione Fino a 60 000 giri / minuto
Cambiador automático de herramientas 16 herramientas	Changeur d'outil automatique 16 outils	Caricatore automatico 16 utensili
Consumo de aire Ionizador desactivado: aprox. 50 l/min a 6 bares, 64 l/min a 8 Ionizador activado: aprox. 80 l/min a 6 bares, 102 l/min a 8 bares	Consommation Air Ioniseur désactivé : env. 50 l/min à 6 bars, 64 l/min à 8 bars Ioniseur activé : env. 80 l/min à 6 bars, 102 l/min à 8 bars	Consumo d'aria Ionizzatore disattivato : ca. 50 l/min a 6 bar, 64 l/min a 8 bar Ionizzatore attivato : ca. 80 l/min a 6 bar, 102 l/min a 8 bar
Eje rotativo A: 360° Eje rotativo B: ± 35°	Axe de rotation A : 360° Axe de rotation B : ± 35°	Asse rotante A: 360° Asse rotante B: ±35°



Grosor del disco hasta 40 mm
Epaisseur de disques jusqu'à 40 mm
Spessore dei dischi fino a 40 mm

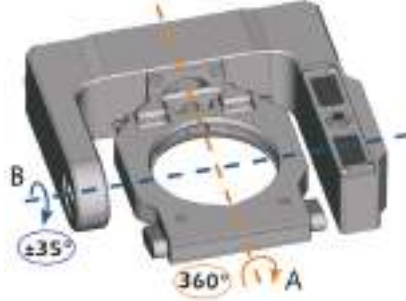

Eje rotativo A: 360°
Eje rotativo B: ± 35°
Axe de rotation A : 360°
Axe de rotation B : ± 35°
Asse rotante A: 360°
Asse rotante B: ±35°



Zirconia Wax PMMA CoCr Peek Acetal

OPCIÓN 3 bloques secos
OPTION 3 blocs à sec
OPZIONE 3 blocchi a secco



Hexoceram Zirconio PMMA Castable resin

OPERA SYSTEM TARGA

FRESADO HÚMERO Y SECO ■ USINAGE À SEC & SOUS EAU ■ LAVORAZIONE A SECCO & UMIDO



Tecnología Direct Clean: le permite cambiar con comodidad entre pulido húmedo y seco. Además de los ionizadores integrados y la ventilación activa del espacio de trabajo, TARGA también tiene una función de secado muy inteligente.

Refrigeración por agua integrada: minimiza de manera significativa la expansión térmica del husillo y el eje Z; mecanizado más rápido con resultados más uniformes y una mayor duración del husillo.

Technologie Direct Clean: permet de basculer facilement entre l'usinage humide et sec. En plus des ioniseurs intégrés et de la ventilation active de l'espace de travail, TARGA dispose également d'une fonction de séchage automatisée.

Refroidissement par eau intégré: minimise considérablement la dilatation thermique de la broche et de l'axe Z; un usinage plus rapide avec des résultats encore plus cohérents et une durée de vie prolongée de la broche.

Tecnologia Direct Clean: consente di passare comodamente dalla lavorazione a umido a quella a secco. Oltre agli ionizzatori integrati e alla ventilazione attiva dello spazio di lavoro, TARGA ha anche una funzione di asciugatura automatica.

Raffreddamento ad acqua integrato: riduce significativamente l'espansione termica del mandrino e dell'asse Z; lavorazione più veloce con risultati ancora più uniformi e durata più lunga del mandrino.



Cargador de hasta 10 discos
Chargeur 10 disques
Caricatore 10 dischi

5 EJES
5 AXES
5 ASSI



SECO
SEC
A SECCO

10 DISCOS
10 DISQUES
10 DISCHI



HÚMEDO
HUMIDE
UMIDO

60 BLOQUES
60 BLOCS
60 BLOCCHI



CERÁMICA DE VIDRIO
VITRO CÉRAMIQUE
VETROCERAMICA

60 PREFRESADO
60 PREMILLÉ



CoCr
TITANE

16 HERRAMIENTAS
16 OUTILS
16 UTENSILI





IONIZADOR INTEGRADO
IONISEUR INTÉGRÉ
IONIZZATORE INTEGRATO

SISTEMA DE SUJECCIÓN DE LOS DISCOS SIN HERRAMIENTAS
SERRAGE AUTOMATIQUE DES DISQUES
BLOCCAGGIO DEL DISCO SENZA ATTREZZI



WEBCAM INTEGRADA
WEBCAM INTÉGRÉE
WEBCAM INTEGRATE

 CARACTERÍSTICAS	 CARACTÉRISTIQUES	 CARATTERISTICHE
Tamaño (ancho x profundo x alto) 580 x 600 x 700 mm	Dimensions (L x P x H) 580 x 600 x 700 mm	Dimensioni (L x P x H) 580 x 600 x 700 mm
Peso ~ 149 kg	Poids ~ 149 kg	Peso ~ 149 kg
Número de ejes 5	Nombre d'axes simultanés 5	Numero d'assi 5
Precisión en repeticiones ± 3 microns	Précision de répétabilité ± 3 microns	Precisione di ripetizione ± 3 microns
Husillo Husillo síncrono que gira hasta 80 000 rpm Potencia máxima 800 vatios	Broche synchrone avec vitesse de rotation jusqu'à 80 000 tr/min Puissance maximale 800 watts	Mandrino sincrono con velocità fino a 80 000 rpm Potenza di picco 800 watts
Cambiador automático de herramientas 16 herramientas	Changeur d'outil automatique 16 outils	Caricatore automatico 16 utensili
Cargador automático 10 discos - soporte 60 bloques	Chargeur automatique 10 disques - support 60 blocs	Cambio automatico 10 dischi - supporto 60 blocchi
Grosor del disco 10 a 40 mm - Ø 98 mm	Épaisseur de disques 10 à 40 mm - Ø 98 mm	Spessore dei dischi 10 a 40 mm - Ø 98,5 mm
Consumo de aire Ionizador desactivado: aprox. 50 l/min a 6 bares, 65 l/min a 8 bares Ionizador activado: aprox. 100 l/min a 6 bares, 110 l/min a 8 bares	Consommation Air Ioniseur désactivé : env. 50 l/min à 6 bars, 65 l/min à 8 bars Ioniseur activé : env. 100 l/min à 6 bars, 110 l/min à 8 bars	Consumo d'aria Ionizzatore disattivato : ca. 50 l/min a 6 bar, 65 l/min a 8 bar Ionizzatore attivato : ca. 100 l/min a 6 bar, 110 l/min a 8 bar
Eje rotativo A de 360 grados Eje rotativo B (quinto eje) de ± 35 grados	Axe de rotation A de 360 degrés Axe de rotation B (5ème axe) de ± 35 degrés	Asse di rotazione A di 360° gradi Asse di rotazione B (asse 5) di ± 35 gradi

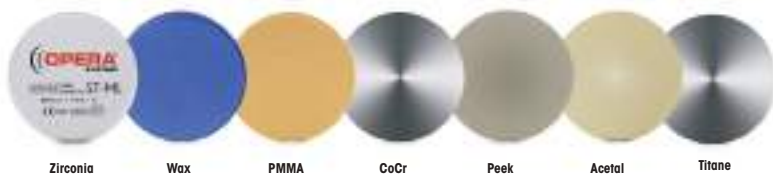
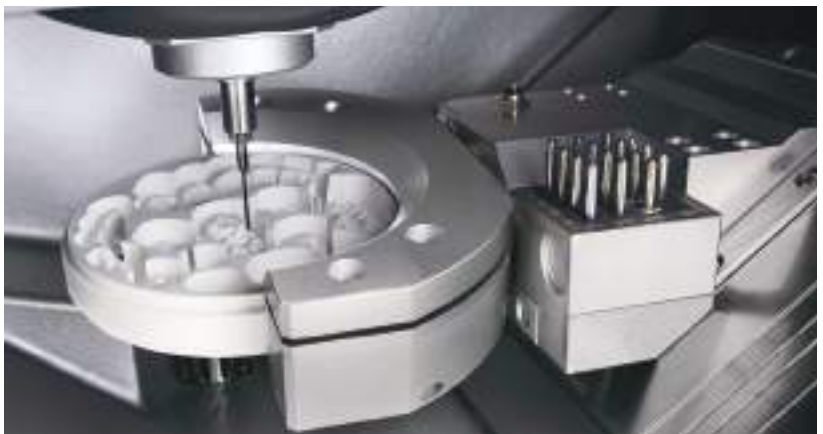
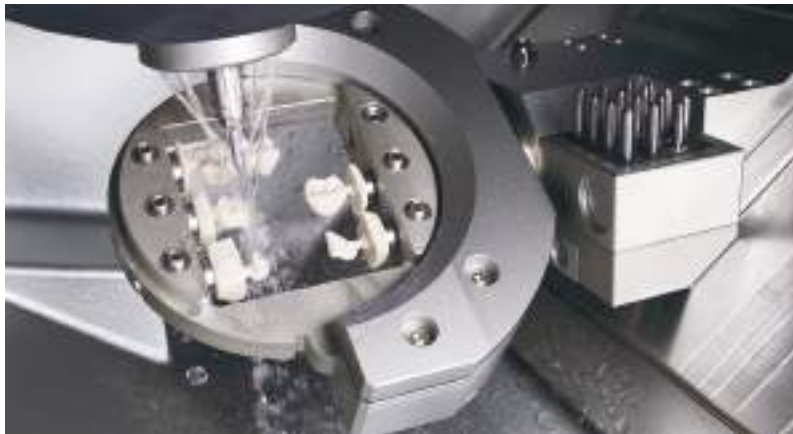

OPERA SYSTEM PRO-EXPERT 5+

FRESADO SECO ■ USINAGE À SEC ■ LAVORAZIONE A SECCO



ES Pro-Expert 5+ es una fresadora dental versátil. **Está equipada con un cambiador de ocho discos.** El cambiador se puede ajustar con discos a través de una cubierta frontal adicional más pequeña. El disco requerido se introduce de manera automática en el dispositivo de fijación cuando es necesario. Por lo tanto, la máquina puede funcionar durante todo el día sin intervención del usuario.

FR Pro-Expert 5+ est une machine à usiner polyvalente pour les laboratoires dentaires. **La machine est équipée d'un changeur automatique de 8 disques.** Le disque approprié à votre travail de fraisage est inséré dans le dispositif de fixation automatique en cas de besoin. Ainsi, la machine peut usiner sans arrêt et sans intervention de l'utilisateur.

IT Pro-Expert 5+ è una macchina versatile per laboratori dentali. **La fresatrice è dotata di un caricatore automatico a 8 dischi.** Se necessario, il disco adatto per il lavoro di fresatura viene inserito nel dispositivo di fresaggio automatico. Pertanto, la macchina può lavorare senza fermarsi e senza l'intervento dell'utente.



5 EJES
5 AXES
5 ASSI



8 DISCOS
8 DISQUES
8 DISCHI



24 BLOQUES
24 BLOCS
24 BLOCCHI



48 PREFRESADO
48 PREMILLED



16 HERRAMIENTAS
16 OUTILS
16 UTENSILI



SECO
SEC
A SECCO



OPCIÓN DE HÚMEDO
HUMIDE EN OPTION
OPZIONE UMIDO



CoCr



IONIZADOR INTEGRADO
IONISEUR INTÉGRÉ
IONIZZATORE INTEGRATO



Cargador automático de hasta 8 discos
Chargeur automatique 8 disques
Caricatore automatico 8 dischi

 CARACTERÍSTICAS	 CARACTÉRISTIQUES	 CARATTERISTICHE
--	--	---

Tamaño (ancho x profundo x alto) / Peso
692 x 445 x 540 mm / ~ 95 kg

Dimensions (L x P x H) / Poids
692 x 445 x 540 mm / ~ 95 kg

Dimensioni (L x P x H) / Peso
692 x 445 x 540 mm / ~ 95 kg

Número de ejes
5

Nombre d'axes simultanés
5

Numero d'assi
5

Precisión en repeticiones
± 3 microns

Précision de répétabilité
± 3 microns

Precisione di ripetizione
± 3 microns

Husillo de alta frecuencia Jäger Potencia nominal 300 W - Potencia de salida máxima 600 W

Mandrin haute fréquence Jäger P. nominale 300 W - P. utile maximale 600 W

Mandrino alta frequenza Jäger P. nominale 300 W - P. utile massima 600 W

Velocidad de rotación
Hasta 60 000 RPM

Vitesse de rotation
Jusqu'à 60 000 tours/minute

Velocità di rotazione
Fino a 60 000 giri / minuto

Cambiador automático de herramientas
16 herramientas

Changeur d'outil automatique
16 outils

Caricatore automatico
16 utensili

Consumo de aire seco comprimido
7 bares min, 80 l/min

Consommation d'air sec comprimé
7 bars min - 80 l/min

Consumo d'aria compressa
7 bars min - 80 l/min

Eje rotativo Ade 360 grados
Eje rotativo B (quinto eje) de ± 30grados
Engrenaje Harmonic Drive®

Axe de rotation A de 360 degrés
Axe de rotation B (5ème axe) de ± 30 degrés
Engrenage de type Harmonic Drive®

Asse di rotazione A di 360 gradi
Asse di rotazione B (quinto asse) di circa 30 Gradi
Ingranaggio di tipo Harmonic Drive®

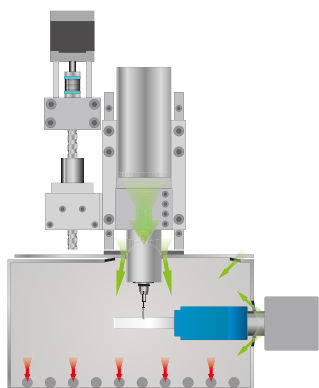

 **Cámara de trabajo protegida e integrada:** Alta protección contra el polvo. Espacio de trabajo seguro. Luz en la cámara de trabajo.

 **Cabine de travail étanche :** Excellente protection à la poussière. Espace de travail sécurisé - Eclairage de l'aire de travail.

 **Cabina di lavorazione ermetica :** Grande resistenza alla polvere - Spazio di lavorazione sicuro - Illuminazione dello spazio di lavoro.



Opción de pulido
Option usinage lubrifié
Opzione frezatura ad umido





Sistema de gestión de aire
Guidage de l'air
Sistema gestionale aria



Tratamiento líquido
Traitement liquide
Trattamento del liquidi

 Pro-expert 5+ se ha diseñado para el procesamiento en seco y en húmedo. ¡Con el kit húmedo opcional (bomba externa), puede fresar todo tipo de cerámica de vidrio y titanio!

 La Pro-Expert 5+ est conçue pour l'usinage à sec et sous eau. Avec le kit humide en option (pompe externe), vous pourrez usiner tous les types de vitrocéramique et le titane !

 Pro-Expert 5+ è progettato per la lavorazione a secco e a umido. Con il kit di lubrificazione disponibile in opzione (pompa esterna) puoi lavorare tutti i tipi di vetroceramica e titanio!

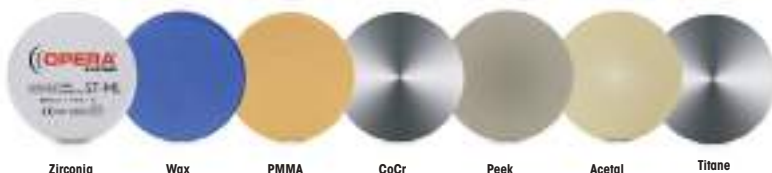

OPCIÓN 3 bloques secos
OPTION 3 blocs à sec
OPZIONE 3 blocchi a secco

OPERA SYSTEM ZR PROD

HORNO DE SINTERIZACIÓN ■ FOUR DE SINTÉRISATION ■ FORNO DI SINTERIZZAZIONE

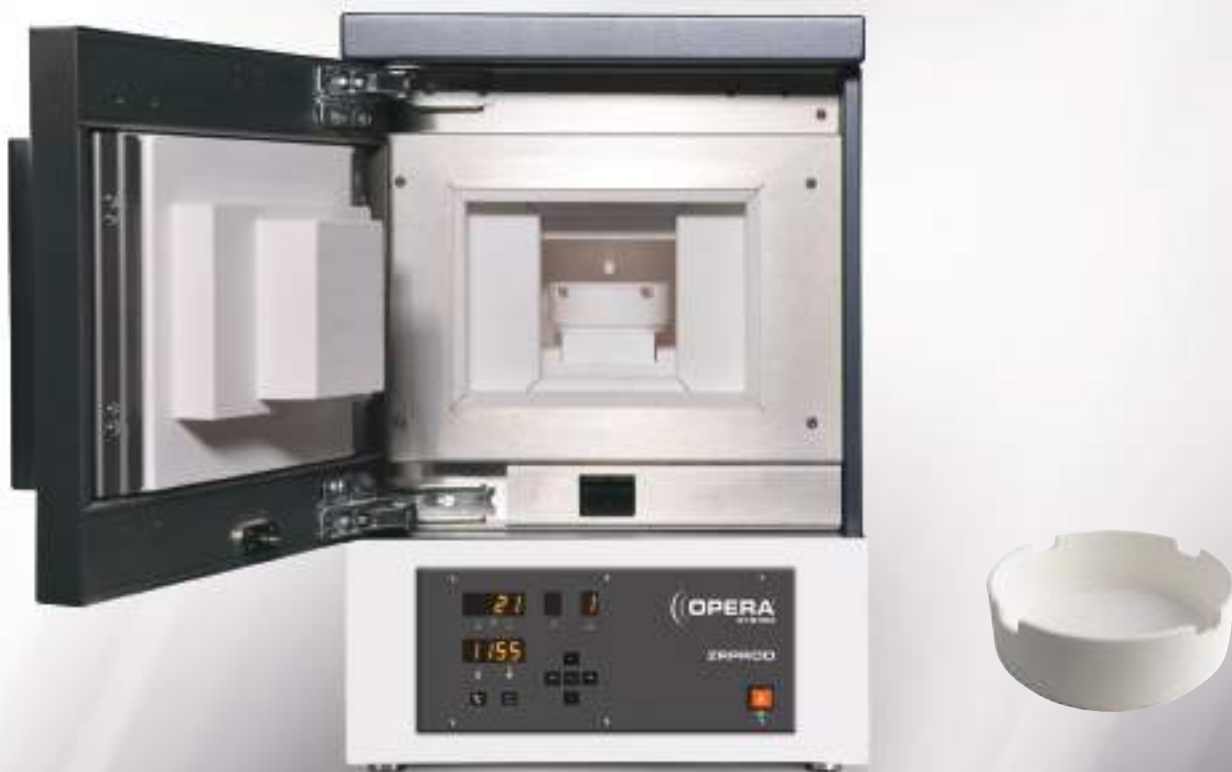

Unidad de alta calidad, eficiente y económica. Compacta, por lo que necesita poco espacio de almacenamiento, puede acomodar un recipiente de sinterización de Ø100 mm **con hasta 20 coronas individuales.** Fácil de usar. Una cerradura electrónica evita la apertura prematura.

Le four de sintérisation ZR PROD est un four de frittage économique et compact. Il peut accueillir une coupelle de frittage d'un diamètre de 100 mm et **jusqu'à 20 éléments unitaires.** Les programmes librement sélectionnables facilitent la manutention et permettent tous les types de frittage en utilisant les programmes standards. La serrure électronique empêche une ouverture prématurée du four.

Il forno di sinterizzazione ZR PROD è un forno di sinterizzazione economico e compatto. Può ospitare una vassoio di sinterizzazione con un diametro di 100 mm e **fino a 20 elementi singoli.** I programmi liberamente selezionabili facilitano la gestione e consentono tutti i tipi di sinterizzazione utilizzando programmi standard. Il blocco elettronico della porta impedisce l'apertura prematura del forno.

9 PROGRAMAS PERSONALIZABLES
9 PROGRAMMES PERSONNALISABLES
9 PROGRAMMI PERSONALIZZABILI



PANTALLA LED DE 7 SEGMENTOS
AFFICHAGE LED 7 SEGMENTS
AFFISSIONE LED 7 SEGMENTI



CIERRE ELECTRÓNICO
VERROUILLAGE ÉLECTRONIQUE DE LA PORTE
BLOCCAGGIO ELETTRONICO DELLA PORTA





TEMPERATURA MÁX. 1650°C
TEMPÉRATURE MAXIMALE 1650°C
TEMPERATURA MASSIMA 1650°C



PROCESO DE 4 PASOS
RÉGLAGE NUMÉRIQUE PRÉCIS DE LA T° JUSQU'À 4 NIVEAUX
REGOLAZIONE PRECISA DELLA TEMPERATURA FINO A 4 LIVELLI



 CARACTERÍSTICAS	 CARACTÉRISTIQUES	 CARATTERISTICHE
Tamaño (ancho x profundo x alto) 400 x 400 x 600	Dimensions (L x P x H) 400 x 400 x 600	Dimensioni (L x P x H) 400 x 400 x 600
Peso ~ 55Kg	Poids ~ 55Kg	Peso ~ 55Kg
Altura de la cámara de calentamiento 42 mm	Hauteur chambre de chauffe 42 mm	Altezza della di riscaldamento 42 mm
Temperatura máx. 1650°C	Température maximale 1650°C	Temperatura massima 1650°C
Bandeja de sinterización 1 x 100/30 mm	Coupelle de frittage 1 x 100/30 mm	Vassoio di sinterizzazione 1 x 100/30 mm
Elementos de calentamiento 4 x MoSi ₂ - Standard	Éléments chauffants 4 x MoSi ₂ - Standard	Elementi riscaldanti 4 x MoSi ₂ - Standard
Tensión 220-240 V / 50/60 Hz	Tension 220-240 V / 50/60 Hz	Voltaggio 220-240 V / 50/60 Hz
Potencia máx. 1300 W	Puissance max. 1300 W	Potenza massima 1300 W
Consumo de energía / ciclo kWh 1 3,8	Consommation d'énergie/cycle kWh 1 3,8	Consumo energetico / ciclo kWh 1 3,8
Termopar PtRh-Pt 140 mm, Tipo S	Thermocouple PtRh-Pt 140 mm, Type S	Termocoppia PtRh-Pt 140 mm, Type S
Velocidad de calentamiento máx. programable 30°C / Min	Taux de chauffage max. programmable 30°C / Min	Max. Velocità di riscaldamento programmabile 30°C / Min
Período de calentamiento mínimo a 1500°C y 230 V 61 min.	Temps de chauffage le plus court à 1500°C à 230 V 61 min.	Tempo di riscaldamento minimo tra 1500°C e 230 V 61 min.
Período de refrigeración mínimo a 300°C 148 min.	Temps de refroidissement le plus court à 300°C 148 min.	Tempo di raffreddamento più breve a 300°C 148 min.
Duración del proceso 239 min. (incl. dwelling time 30 min.)	Durée du processus 239 min. (inclus le temps à demeure 30 min.)	Durata del processo 239 min. (incluso il limite di tempo di 30 minuti)



OPERA SYSTEM ZR SPEED

HORNO DE SINTERIZACIÓN ■ FOUR DE SINTÉRISATION ■ FORNO DI SINTERIZZAZIONE



Ciclo rápido: exclusivo del ZR SPEED para una máxima eficiencia en un tiempo mínimo; 73 minutos. El ZR SPEED tiene 30 programas adicionales para la sinterización rápida de ZrO₂.

Fonction "Cycle Rapide" : Avec ZR SPEED, fritez votre zircone Opera System Viva en 73 minutes seulement ! Grâce à la fonction "Cycle Rapide" le frittage de vos restaurations en zircone n'a jamais été aussi court et efficace.

Ciclo rapido : lo ZR SPEED, sinterizza la vostra zirconia Opera System Viva in solo 73 minuti! Grazie alla funzione "ciclo rapido" la sinterizzazione dei vostri restauri in zirconia non è stata mai così breve ed efficace.

CICLO NORMAL ±132 MIN. O RÁPIDO ±73 MIN.
CYCLE CLASSIQUE ±132 MIN. OU RAPIDE ±73 MIN.
CICLO CLASSICO ±132 MIN. O RAPIDO ±73 MIN.



COCCIÓN DE ALTA PRECISIÓN
CUISSON HAUTE PRÉCISION
COTTURA AD ALTA PRECISIONE



REGENERA LOS ELEMENTOS DE CALENTAMIENTO
RÉGÉNÉRATION DES ÉLÉMENTS CHAUFFANTS
RIGENERA GLI ELEMENTI RISCALDANTI



MAX.1650°C



30 PROGRAMAS
30 PROGRAMMES
30 PROGRAMMI



 CARACTERÍSTICAS	 CARACTÉRISTIQUES	 CARATTERISTICHE
Tamaño (ancho x profundo x alto) 39 x 50 x 79 cm	Dimensions (L x P x H) 39 x 50 x 79 cm	Dimensioni (L x P x H) 39 x 50 x 79 cm
Peso ~ 60 Kg	Poids ~ 60 Kg	Peso ~ 60 Kg
Temperatura de sinterización máx. 1650°C / 3002°F	Température max. de sinterisation 1650°C	Temperatura massima sinterizzazione 1650°C
Número de programas 30 - Totalmente programable	Nombre de programmes 30 programmes entièrement paramétrables	Numero di programmi 30 programmi integralmente parametrizzabili
Productividad 60 coronas sencillas o disco de sinterización	Productivité 60 couronnes simples ou disque de frittage	Produttività 60 corone singole o disco sinterizzante
Capacidad de la cámara de cocción 2 Bandeja de sinterización Ø 120/30 mm	Capacité de la chambre de chauffe 2 coupelles Ø 120/30 mm	Capacità della camera di riscaldamento 2 Vassoio di sinterizzazione Ø 120/30 mm
Pantalla Pantalla LCD - 4 fases	Ecran Affichage LCD - 4 niveaux	Schermo LCD display - 4 linee
Precisión de la temperatura a 1500°C +/- 3°C	Précision de la température à 1500°C +/- 3°C	Accuratezza della temperatura a 1500°C +/- 3°C
Termopar PtRh-Pt, tipo S	Thermocouple PtRh-Pt, type S	Termocoppia PtRh-Pt, type S
Elementos de calentamiento Disilicida de molibdeno de alta calidad	Éléments chauffants High-quality molybdenum-disilicide	Elementi riscaldanti Disilicida al molibdeno di alta qualità
Potencia máx. 3200 W	Puissance max. 3200 W	Potenza massima 3200 W
Fuente de alimentación disponible 200-240 V ; 50/60 Hz	Alimentation électrique disponible 200-240 V ; 50/60 Hz	Alimentazione elettrica disponibile 200-240 V ; 50/60 Hz

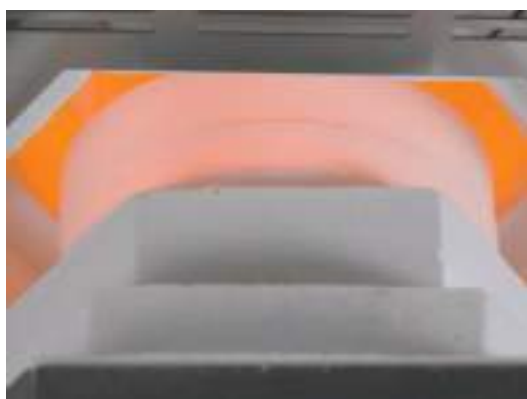

OPERA SYSTEM MASTER HT

PORCELANA Y CRISTALIZACIÓN ■ CÉRMIQUE & CRISTALLISATION ■ CERAMICA & CRISTALLIZZAZIONE



El horno MASTER HT cuenta con 200 programas gratuitos para todas las cerámicas convencionales + 50 programas de alta temperatura para cristalizar cerámicas a base de alúmina, cerámicas de vidrio, disilicato de litio y largos ciclos de cocción. La gama de programación totalmente adaptable trata todos los materiales cerámicos del mercado. Presenta una **calibración de vacío automática y precisa** para una translucidez inmaculada y para dar vitalidad a las restauraciones de cerámica.

200 programmes libres pour toutes les céramiques conventionnelles + 50 programmes HT conçus pour la cristallisation des céramiques à base d'alumine, les vitrocéramiques, les disilicates de lithium et les cycles de cuisson longue durée. La gamme de programmation entièrement adaptable gère tous les matériaux céramiques sur le marché. La fonction **"calibration automatique du vide"** maintient la translucidité et la vitalité de l'élément céramique.

200 programmi liberi per tutte le ceramiche convenzionali + 50 programmi ad alta temperatura progettata per la cristallizzazione della ceramica di allumina, vetroceramica, disilicato di litio e cicli di cottura a lunga durata. La gamma di programmazione completamente adattabile gestisce tutti i materiali ceramici presenti sul mercato. La funzione **"calibrazione automatica del vuoto"** mantiene la traslucenza e la vitalità dell'elemento ceramico.



200 PROGRAMAS GRATUITOS + 50 PROGRAMAS DE ALTA T°
200 PROGRAMMES + 50 PROGRAMMES HAUTE T°
200 PROGRAMMI LIBERI + 50 PROGRAMMI T° ALTA



COCCIÓN DE ALTA PRECISIÓN
CUISSON HAUTE TEMPÉRATURE
COTTURA AD ALTA PRECISIONE



CONTROL TOTAL DEL PROCESO DE COCCIÓN
CONTRÔLE TOTAL DU PROCESSUS DE CUISSON
CONTROLLO TOTALE DEL PROCESSO DI COTTURA



MUFLA DE CUARZO
MOUFLE QUARTZ
MUFFOLA AL QUARZO



MAX. 1200°C
MAX. 2192°F



 CARACTERÍSTICAS	 CARACTÉRISTIQUES	 CARATTERISTICHE
Tamaño (ancho x profundo x alto) 230 x 240 x 570 mm	Dimensions (L x P x H) 230 x 240 x 570 mm	Dimensioni (L x P x H) 230 x 240 x 570 mm
Peso ≈13,5 Kg	Poids ≈13,5 Kg	Peso ≈13,5 Kg
Temperatura máx. 1200°C (2192°F)	Température maximale 1200°C	Temperatura massima 1200°C
Temperatura de cocción máx. 1180°C (2156°F)	Température maximale de cuisson 1180°C	Temperatura massima di cottura 1180°C
Opción de programas 200 programas gratuitos + 50 alta temperatura	Nombre de programmes 200 programmes libres + 50 Haute T°	Opzione programmi 200 programmi gratuiti + 50 alta temperatura
Segmento de temperatura 1 a 120°C (34°C a 248°F)	Vitesse de montée en température 1 a 120°C	Velocità di aumento della temperatura 1 a 120°C
Señal acústica - Permite conocer el estado del horno de forma remota	Signal acoustique Permet de connaître le statut du four à distance	Segnale acustico Permette di conoscere lo stato del forno da remoto
Puerto USB para cargar con facilidad los programas de cocción	Port USB Permet de charger les programmes facilement	Porta USB Permette di caricare facilmente i programmi
Pantalla Pantalla digital intuitiva en color	Ecran LCD - Affichage numérique intuitif en couleur	schermo LCD: display digitale intuitivo a colori
Tamaño de la cámara de cocción ø 95 x H 65 mm	Dimensions chambre de chauffe ø 95 x H 65 mm	Dimensioni camera di riscaldamento ø 95 x H 65 mm
Dimensiones de la tabla de cocción ø 90 mm	Dimensions socle de cuisson ø 90 mm	Dimensioni piano di cottura ø 90 mm
Intervalo de temperatura 100°C a 1100°C - 110°C a 1180°C	Plage de températures 100°C à 1100°C - 110°C à 1180°C	Intervallo di temperatura 100°C to 1100°C - 110°C to 1180°C
Fuente de alimentación CA 110-120V, 50/60Hz-CA 200-240V, 50/60Hz	Alimentation secteur CA 110-120V, 50/60Hz-CA 200-240V, 50/60Hz	Alimentazione elettrica CA 110-120V, 50/60Hz-CA 200-240V, 50/60Hz
Consumo de energía 110V - 15 A - 230V - 8 A	Consommation max. 110V - 15 A - 230V - 8 A	Consumo massimo 110V - 15 A - 230V - 8 A
Garantía 3 años de repuestos Excluido transporte y mano de obra Muffa: 3 años o 3000 horas de trabajo Bomba de vacío: 1 año	Garantie 3 ans pièces détachées Hors transport et main d'œuvre Moufle : 3ans ou 3000 heures de travail Pompe à vide : 1 an	Garanzia 3 anni pezzi di ricambio Esclusi trasporto e lavoro Muffola : 3 anni o 3000 ore di lavoro Pompa a vuoto : 1 anno





Muffa de cuarzo
Quartz muffle



Bandeja Termo opcional
Thermo Tray option

 Muffa de tubo de cuarzo: proporciona la misma radiación térmica para garantizar una cocción precisa y fiable siempre. Proporciona una refrigeración más rápida para una mayor disponibilidad entre ciclos.

 Moufle avec tube en quartz : Permet un rayonnement thermique homogène pour des résultats optimaux de cuisson des zones cervicales aux bords libres. Le refroidissement est rapide pour réduire le temps d'attente entre deux cycles.

 Muffola con tubo di quarzo: consente una radiazione termica omogenea per risultati di cottura precisi e affidabili. Il raffreddamento rapido permette di ridurre il tempo di attesa tra due cicli.



Katana™ UTMZ Zirconia - Kuraray Noritake Dental

OPERA SYSTEM VIVA

MATERIALES CAD-CAM ■ MATÉRIAUX CAD-CAM ■ MATERIALI CAD-CAM



El CAD/CAM OperaSystem® ofrece una amplia variedad de materiales de alta calidad para todos los usos y tipos de restauraciones. Nos gustaría destacar en particular nuestra gama de zirconia Viva Opera System que se caracteriza por sus distintos niveles de translucidez y propiedades mecánicas.

La solution CAD/CAM Opera System® vous propose une grande diversité de matériaux de haute qualité, pour toutes les indications et tous les types de restaurations. Nous attirons votre attention tout particulièrement sur notre gamme de zircons Viva Opera System qui se caractérise par différents niveaux de translucidité et de propriétés mécanique. **Une zirconie d'avant-garde avec un dégradé de teintes naturelles et une translucidité exceptionnelle.**

La soluzione CAD / CAM Opera System® offre un'ampia varietà di materiali di alta qualità, per tutte le indicazioni e tutti i tipi di restaurari. Attiriamo la vostra attenzione in particolare sulla nostra gamma di zirconio Viva Opera System che è caratterizzato da diversi livelli di traslucidità e proprietà meccaniche. **Una zirconia d'avanguardia con una gradazione di tonalità traslucidità naturale ed eccezionale.**



Wax



Viva W - CE 0197
TR 39 % - 1200 MPA



Viva PS - CE 0197
TR 43 % - 1200 MPA



Viva VS - CE 0197
TR 44-47 % - 800-1100 MPA



PMMA IDODENTINE - CE 0120



PMMA - CE 0470



Pink PMMA - CE 0470



PMMA TRANS - CE 0470



CAST Ca



CARACTERÍSTICAS

Viva UT-ML - Perfecto para prótesis anteriores, como las carillas. De hecho, esta es la zirconia con uno de los niveles de translucidez más altos del mercado.

Viva ST-ML - Más opacidad en el área cervical y más translucidez en la zona incisal. Alcanzará resultados de primera calidad, sin importar el color del pilar.

Viva HT-ML - Fabricado para grandes marcos dentales. Su opacidad natural lo convierte en la base ideal para cubrirlo con cerámica hecha a mano.

Viva HT - Alta resistencia a la flexión. Zirconia perfecta para estructuras unitarias y puentes de gran tamaño. La gama HT es perfecta para el refuerzo monolítico.

Viva W - Solución completa en zirconia blanca, combina una excelente translucidez y una alta resistencia a la flexión, ideal para coronas y puentes de gran tamaño.

Viva PS - Solución completa en zirconia precoloreada, combina una excelente translucidez y una alta resistencia a la flexión, perfecta para puentes, empastes y recubrimiento.

Viva VS - Altamente translúcida + Multicapa + Resistencia a la flexión progresiva + Preteñido. Perfecta para cualquier tipo de restauración. Ideal para puentes de un solo marco y de gran tamaño.



CARACTÉRISTIQUES

Viva UT-ML - Idéale pour les prothèses antérieures telles que les facettes. Il s'agit en fait d'une zircone avec une translucidité parmi les plus élevées du marché.

Viva ST-ML - Une plus grande opacité dans la zone cervicale et une translucidité accrue dans la zone incisive. Des résultats parfaits, quelle que soit la couleur du pilier.

Viva HT-ML - Conçue pour les armatures de grand taille. Grâce à son opacité naturelle, elle constitue une base idéale à recouvrir de céramiques réalisées manuellement.

Viva HT - Haute résistance à la flexion. Zircone idéale pour les armatures unitaires et les bridges longue portée. La gamme HT est adaptée aux armatures monolithiques.

Viva W - Hautement translucide et blanche. Cette zircone constitue un choix judicieux dans la plupart des cas.

Viva PS - Hautement translucide Monochrome & pré-teintée. Idéale pour les environnements postérieurs exigeants.

Viva VS - Hautement translucide + Multicouche + Résistance à la flexion progressive + pré-teintée. Convient pour tout type d'indication. Idéale pour les armatures unitaires et les bridges longue portée.



CARATTERISTICHE

Viva UT-ML - Ideale per protesi anteriori come sfaccettature. Infatti è uno delle zirconie con traslucidità più alta del mercato.

Viva ST-ML - Maggiore opacità nella zona cervicale e maggiore traslucidità nell'area incisale. Risultati perfetti, indipendentemente dal colore del Abutment

Viva HT-ML - Progettato per telai di grandi dimensioni. Grazie alla sua opacità naturale, è una base ideale per la copertura di ceramiche fatte a mano.

Viva HT - Elevata resistenza alla flessione Zirconia, ideale per telai unitari e ponti a lunga portata. La gamma HT è adatta per il rinforzo monolitico.

Viva W - Soluzione completa in zirconia bianca, combina un'ottima traslucidità ed alta resistenza alla flessione è ideale per corone e ampie strutture da ceramizzare.

Viva PS - Soluzione completa in zirconia pre-colorata, combina un'ottima traslucidità ed alta resistenza alla flessione indicato per ponti, inlay e onlay.

Viva VS - Altamente traslucido + Multistrato + Resistenza alla flessione progressiva + pre-colorato. Adatto a qualsiasi tipo di restauro. Ideale per ponti gran portata e corone semplici.

VIVA HT - HTML - STML - UTML :



Anillo de plástico: No vibra durante el fresado ni durante el apriete.

Anneau plastique : Pas de vibration pendant l'usinage, pas de casse lors du serrage.

Anello in plastica : Limita le vibrazioni durante la lavorazione e evita rotture durante il serraggio



Viva HT - CE 0120
TR 31 % - 1125 MPA



Viva HT-ML - CE 0120
TR 31 % - 1125 MPA



Viva ST-ML - CE 0120
TR 38 % - 748 MPA



Viva UT-ML - CE 0120
TR 43 % - 557 MPA



Incisinal



X-Ray - CE 0470



Model



Peek - CE 0546



Acetal Dental - CE 0546

OPERA SYSTEM VIVA

RECOMENDACIONES ■ APPLICATIONS ■ INDICAZIONI



	ZR W	ZR PS	ZR VS	ZR HT	ZR HT-ML	ZR ST-ML	ZR UT-ML	WAX	PMMA	PINK PMMA	PMMA TRANS	PEEK	MODEL	CAST	X-RAY	ACETAL
Elementos	✓	✓	✓	✓	✓	✓		✓	✓		✓			✓		
Puente	✓	✓	✓	✓	✓	✓		✓	✓		✓			✓		
Contorno completo de la corona	✓	✓	✓	✓	✓	✓	✓	✓	✓		✓			✓	✓	
Contorno completo del puente	✓	✓	✓	✓	✓	✓		✓	✓		✓			✓	✓	
Carilla	✓	✓	✓			✓	✓	✓	✓		✓			✓		
Empastes / recubrimientos	✓	✓	✓	✓	✓	✓	✓	✓	✓		✓			✓		
Maryland	✓	✓	✓	✓	✓			✓	✓		✓			✓		
Unidad marco en Ti-Bas	✓	✓	✓	✓	✓	✓	✓	✓	✓		✓			✓		
Marco de puente sobre Ti-Base	✓	✓	✓	✓	✓	✓		✓	✓		✓			✓		
Aconchado provisional	✓	✓	✓						✓							
Fresado en marco	✓	✓	✓	✓	✓			✓	✓		✓			✓		
Atache	✓	✓	✓					✓			✓			✓		
Pilar	✓	✓	✓	✓	✓	✓		✓	✓		✓			✓		
Puente de implante	✓	✓	✓	✓	✓	✓		✓	✓		✓			✓		
Puente de implante con encía	✓	✓	✓	✓	✓			✓	✓		✓			✓		
Marco parcial								✓				✓		✓		✓
Dentadura postiza completa										✓						
Milling model													✓			

OPERA SYSTEM VIVA W



ZIRCONIA ALTAMENTE TRANSLÚCIDA ■ ZIRCONIUM HAUTEMENT TRANSLUCIDE ■ ZIRCONIA ALTAMENTE TRANSLUCIDA



 Circonita muy translúcida y blanca ideal para coronas y puentes de gran envergadura.

 Zircone hautement translucide et blanche. Cette zircone constitue un choix judicieux dans la plupart des cas.

 Zirconia altamente traslucida e bianca. ideale per corone e ampie strutture da ceramizzare

 CARACTERÍSTICAS	 CARACTÉRISTIQUES	 CARATTERISTICHE
Resistencia a la flexión >1200 MPa	Résistance à la flexion >1200 MPa	Resistenza a flessione >1200 MPa
Expansión térmica (25-500°C) (10.5 ± 1.0) × 10 ⁻⁶ .K ⁻¹	Expansion thermique (25-500°C) (10.5 ± 1.0) × 10 ⁻⁶ .K ⁻¹	Espansione termica (25-500°C) (10.5 ± 1.0) × 10 ⁻⁶ .K ⁻¹
Composición ZrO ₂ + HfO ₂ , Y ₂ O ₃ , Al ₂ O ₃ ,...	Composition ZrO ₂ + HfO ₂ , Y ₂ O ₃ , Al ₂ O ₃ ,...	Composizione ZrO ₂ + HfO ₂ , Y ₂ O ₃ , Al ₂ O ₃ ,...
Translucidez 39 %	Transparence 39 %	Traslucenza 39 %
Temperatura de sinterización ideal 1530°C for 2 hours	Température de sinterisation idéale 1530°C pendant 2 heures	Temperatura di sinterizzazione ideale 1530°C per 2 ore

White	10 mm	OSW / 10
White	14 mm	OSW / 14
White	18 mm	OSW / 18
White	22 mm	OSW / 22
White	25 mm	OSW / 25



OPERA SYSTEM VIVA PS

HT ZIRCONIA PRE-SOMBREADO ■ ZR HT PRÉ-TEINTÉE ■ ZIRCONIA ALTAMENTE TRANSLUCIDA & PRE-COLORATA



ES Viva PS Solución completa en zirconia precoloreada, combina excelente translucidez y alta resistencia a la flexión apta para puentes, empastes y recubrimientos.

FR Zirconie hautement translucide Monochrome & pré-teintée. Zirconie pré-teintée dotée d'une excellente translucidité. Idéale pour les bridges, les inlays et les onlays.

IT Viva PS Soluzione completa in zirconia pre-colorata, combina un'ottima trasparenza ed alta resistenza alla flessione indicato per ponti, inlay e onlay



ES CARACTERÍSTICAS	FR CARACTÉRISTIQUES	IT CARATTERISTICHE
Resistencia a la flexión >1200 MPa	Résistance à la flexion >1200 MPa	Resistenza a flessione >1200 MPa
Expansión térmica (25-500°C) (10.5 ± 1.0) × 10 ⁻⁶ .K ⁻¹	Expansion thermique (25-500°C) (10.5 ± 1.0) × 10 ⁻⁶ .K ⁻¹	Espansione termica (25-500°C) (10.5 ± 1.0) × 10 ⁻⁶ .K ⁻¹
Composición Polvo de circonio nanómetro Fe ₂ O ₃ , Pr ₂ O ₃ , Er ₂ O ₃ ,...	Composition Poudre zr nanométrique Fe ₂ O ₃ , Pr ₂ O ₃ , Er ₂ O ₃ ,...	Composizione Nanometer zirconia powder Fe ₂ O ₃ , Pr ₂ O ₃ , Er ₂ O ₃ ,...
Translucidez 43%	Transparence 43%	Traslucenza 43%
Temperatura de sinterización ideal 1530°C durante 2 horas	Température de sintérisation idéale 1530°C pendant 2 heures	Temperatura di sinterizzazione ideale 1530°C per 2 ore
A2 10 mm OS PS A2 / 10	A3 14 mm OS PS A3 / 14	B2 18 mm OS PS B2 / 18
A2 14 mm OS PS A2 / 14	A3 18 mm OS PS A3 / 18	B2 22 mm OS PS B2 / 22
A2 18 mm OS PS A2 / 18	A3 22 mm OS PS A3 / 22	B2 25 mm OS PS B2 / 25
A2 22 mm OS PS A2 / 22	A3 25 mm OS PS A3 / 25	C2 10 mm OS PS C2 / 10
A2 25 mm OS PS A2 / 25	B2 10 mm OS PS B2 / 10	C2 14 mm OS PS C2 / 14
A3 10 mm OS PS A3 / 10	B2 14 mm OS PS B2 / 14	C2 18 mm OS PS C2 / 18
		C2 22 mm OS PS C2 / 22
		C2 25 mm OS PS C2 / 25
		D2 10 mm OS PS D2 / 10
		D2 14 mm OS PS D2 / 14
		D2 18 mm OS PS D2 / 18
		D2 22 mm OS PS D2 / 22
		D2 25 mm OS PS D2 / 25

OPERA SYSTEM VIVA VS

ZR MULTICAPA Y PRESOMBREADO ■ ZR MULTICOUCHE & PRÉ-TEINTÉE ■ ZR MULTI-STRATI & COLORATA NELLA MASSA



Viva VS - Altamente translúcido + Multicapa + resistencia a la flexión progresiva + tintado. Apto para cualquier tipo de restauración. Perfecto para marco simple y largo.

Hautement Translucide + Multicouche + résistance à la flexion progressive. La transparence est graduelle de 44% à 47%. La résistance à la flexion est également progressive de 800 à 1100 mpa. La zircone VS convient pour tout type d'indication, elle est idéale pour les armatures unitaires et les bridges longue portée.

Viva VS - Altamente traslucido + Multistrato + Resistenza alla flessione progressiva + pre-colorato. Adatto a qualsiasi tipo di restauro. Ideale per ponti a telaio singolo e a lunga luce.



CARACTERÍSTICAS	CARACTÉRISTIQUES	CARATTERISTICHE
Resistencia a la flexión 800 a 1100 MPa	Résistance à la flexion 800 à 1100 MPa	Resistenza a flessione 800 a 1100 MPa
Expansión térmica (25-500°C) (10.5 ± 0.5) × 10 ⁻⁶ .K ⁻¹	Expansion thermique (25-500°C) (10.5 ± 0.5) × 10 ⁻⁶ .K ⁻¹	Espansione termica (25-500°C) (10.5 ± 0.5) × 10 ⁻⁶ .K ⁻¹
Composición ZrO ₂ + HfO ₂ , Y ₂ O ₃ , Fe ₂ O ₃ , Al ₂ O ₃ , Er ₂ O ₃ ,...	Composition ZrO ₂ + HfO ₂ , Y ₂ O ₃ , Fe ₂ O ₃ , Al ₂ O ₃ , Er ₂ O ₃ ,...	Composizione ZrO ₂ + HfO ₂ , Y ₂ O ₃ , Fe ₂ O ₃ , Al ₂ O ₃ , Er ₂ O ₃ ,...
Translucidez 44 % a 47%	Transparence 44 % à 47%	Traslucenza 44 % a 47%
Temperatura de sinterización ideal 1480°C durante 2 horas	Température de sinterisation idéale 1480°C pendant 2 heures	Temperatura di sinterizzazione ideale 1480°C per 2 ore

A1 14 mm OS VS A1 / 14	A3 14 mm OS VS A3 / 14	B1 14 mm OS VS B1 / 14	C2 18 mm OS VS C2 / 18
A1 18 mm OS VS A1 / 18	A3 18 mm OS VS A3 / 18	B1 18 mm OS VS B1 / 18	C2 22 mm OS VS C2 / 22
A1 22 mm OS VS A1 / 22	A3 22 mm OS VS A3 / 22	B1 22 mm OS VS B1 / 22	D2 14 mm OS VS D2 / 14
A2 14 mm OS VS A2 / 14	A3 25 mm OS VS A3 / 25	B2 14 mm OS VS B2 / 14	D2 18 mm OS VS D2 / 18
A2 18 mm OS VS A2 / 18	A3,5 14 mm OS VS A3,5 / 14	B2 18 mm OS VS B2 / 18	D2 22 mm OS VS D2 / 22
A2 22 mm OS VS A2 / 22	A3,5 18 mm OS VS A3,5 / 18	B2 22 mm OS VS B2 / 22	
A2 25 mm OS VS A2 / 25	A3,5 22 mm OS VS A3,5 / 22	C2 14 mm OS VS C2 / 14	

VITA® registered trademark of VITA Zahnfabrik H. Rauter GmbH & Co.

OPERA SYSTEM VIVA HT

ZR ALTAMENTE TRANSLÚCIDA ■ ZR HAUTEMENT TRANSLUCIDE ■ ZR ALTAMENTE TRANSLUCIDA



 Esta zirconia altamente translúcida tiene una calidad excepcional y constante que ofrece una estética notable. Es muy flexible por lo que se puede utilizar en estructuras de una sola unidad y puentes grandes. La gama HT monolíticosombreado es adecuada para marcos.

 La zirconie Viva HT est une zirconie hautement translucide de qualité exceptionnelle et constante, et propose une esthétique remarquable. Cette zirconie présente une haute résistance à la flexion : elle est idéale pour les armatures unitaires et les bridges longue portée. La gamme HT est adaptée aux armatures monolithiques.

 Viva HT zirconia è una zirconia altamente traslucida di qualità eccezionale e costante che offre una notevole estetica. Questa zirconia ha un'alta resistenza alla flessione: è ideale per armature unitarie e ponti a lunga portata. La gamma HT è adatta per il rinforzo monolitico.

Ant.corona
Couronne Ant.
Corone Ant.

Post.corona
Couronne Post.
Corone Post.

Bridge
Bridge
Ponti

Long-span bridge
Bridge longue portée
Ponti di lunga portata

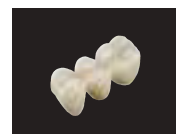
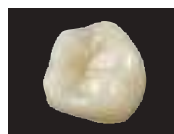
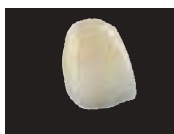

BLANCA - BLANCHE -BLANCA HT OW ≈ WHITE

HTOW	10 mm	OS5 2111 / 10
HTOW	14 mm	OS5 2122 / 14
HTOW	18 mm	OS5 2133 / 18
HTOW	22 mm	OS5 2144 / 22
HTOW	26 mm	OS5 2155 / 26

PRECOLOREADA -TEINTÉE - COLORATA NELLA MASSA HT 2W ≈ A2*

HT2W	10 mm	OS5 2251 / 10
HT2W	14 mm	OS5 2262 / 14
HT2W	18 mm	OS5 2273 / 18
HT2W	22 mm	OS5 2284 / 22
HT2W	26 mm	OS5 2295 / 26



PRECOLOREADA - TEINTÉE - COLORATA NELLA MASSA HT 3W ≈ A3*

HT3W	10 mm	OS5 2861/10
HT3W	14 mm	OS5 2872/14
HT3W	18 mm	OS5 2883/18
HT3W	22 mm	OS5 2894/22
HT3W	26 mm	OS5 2905/26

*VITA® registered trademark of VITA Zahnfabrik H. Rauter GmbH & Co.



Photo: KATANAW Zirconia HT12

 CARACTERÍSTICAS	 CARACTÉRISTIQUES	 CARATTERISTICHE
Resistencia a la flexión 1125 MPa	Résistance à la flexion 1125 MPa	Resistenza alla flessione 1125 MPa
Expansión térmica (25-500°C) 9.9	Expansion thermique (25-500°C) 9.9	Espansione termica (25-500°C) 9.9
Composición ZrO ₂ + HfO ₂ , Y ₂ O ₃ etc.	Composition ZrO ₂ + HfO ₂ , Y ₂ O ₃ etc.	Composizione ZrO ₂ + HfO ₂ , Y ₂ O ₃ etc.
Translucidez 30,5 %	Transparence 30,5 %	Traslucenza 30,5 %
Temperatura de sinterización 1500°C	Température de frittage 1500°C	Temperatura di sinterizzazione 1500°C

 Kuraray Noritake Dental Inc.
1621 Sakazu, Kurashiki, Okayama 710-0801, Japan

 0120



Katanaw Zirconia - Kuraray Noritake Dental

OPERA SYSTEM VIVA HT-ML

ZIRCONIA MULTICAPAS ■ ZIRCONE MULTICOUCHES ■ ZIRCONIA MULTI-STRATI



¿Marcos similares a la dentina de zirconia? ¡Sí! La luz refleja su opacidad natural y el revestimiento de cerámica en la parte superior aporta el resultado más natural. Esta zirconita también viene con un degradado de color natural. La opacidad aumenta desde el área incisal hasta el área cervical como en un diente real (natural).

Colores degradados integrados - 4 capas - Sin inmersión, sin secado - Restauraciones monolíticas excepcionales - Posibles estratificaciones. La alta resistencia a la flexión de la zirconia es perfecta para estructuras de una sola unidad y puentes largos.

Des armatures à l'aspect dentine réalisées en zirconie ? C'est possible ! La lumière reflète l'opacité naturelle. Le montage céramique offre un rendu parfaitement naturel. Cette zirconie est également dotée d'un dégradé de teintes naturelles.

Dégradé de couleurs intégré - 4 couches - Pas de trempage, pas de séchage - Réalisation de restaurations monolithiques exceptionnelles - Stratification possible.

La Zr HT-ML Multi couches présente une haute résistance à la flexion et est idéale pour les armatures unitaires et les bridges longue portée.

Strutture simili alla dentina in zirconia? È possibile! La luce riflette la naturale opacità. Il montaggio della ceramica offre una resa perfettamente naturale. Questa zirconia ha anche una graduazione di sfumature naturali.

Gradazione di colore incorporata - 4 strati - Nessun immersione, nessuna essiccazione - Restauri monolitici eccezionali - Possibilità di stratificazione. Il multistrato Zr HT-ML ha un'elevata resistenza alla flessione ed è ideale per armature unitarie e ponti a campata lunga.

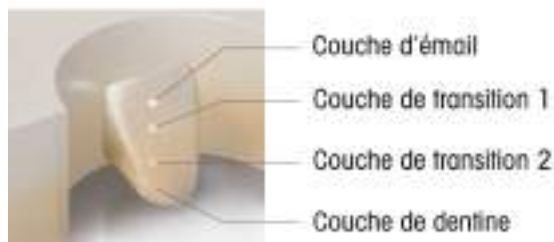

Ant.corona Couronne Ant. Corone Ant.	Post.corona Couronne Post. Corone Post.	Bridge ⁽¹⁾ Bridge ⁽¹⁾ Ponti ⁽¹⁾	Puente largo Bridge longue portée Ponti di lunga portata
--	---	--	--



A1	14 mm	OS5 56942 / 14	A3	14 mm	OS5 57002 / 14	B2	18 mm	OS5 57133 / 18	C3	14 mm	OS5 57242 / 14
A1	18 mm	OS5 56953 / 18	A3	18 mm	OS5 57013 / 18	B2	22 mm	OS5 57144 / 22	C3	18 mm	OS5 57253 / 18
A1	22 mm	OS5 56964 / 22	A3	22 mm	OS5 57024 / 22	B3	14 mm	OS5 57182 / 14	D3	14 mm	OS5 57302 / 14
A2	14 mm	OS5 56972 / 14	A3,5	14 mm	OS5 57032 / 14	B3	18 mm	OS5 57163 / 18	*VITA® registered trademark of VITA Zahnfabrik H. Rauter GmbH & Co.		
A2	18 mm	OS5 56983 / 18	A3,5	18 mm	OS5 57043 / 18	C2	14 mm	OS5 57212 / 14			
A2	22 mm	OS5 56994 / 22	B2	14 mm	OS5 57122 / 14	C2	18 mm	OS5 57223 / 18			



Kuraray™ Zirconia UT-ML - Kuraray Noritake Dental

 CARACTERÍSTICAS	 CARACTÉRISTIQUES	 CARATTERISTICHE
Resistencia a la flexión 1125 MPa	Résistance à la flexion 1125 MPa	Resistenza alla flessione 1125 MPa
Expansión térmica (25-500°C) 9.9	Expansion thermique (25-500°C) 9.9	Espansione termica (25-500°C) 9.9
Composición ZrO ₂ + HfO ₂ , Y ₂ O ₃ etc.	Composition ZrO ₂ + HfO ₂ , Y ₂ O ₃ etc.	Composizione ZrO ₂ + HfO ₂ , Y ₂ O ₃ etc.
Translucidez 30,5 %	Transparence 30,5 %	Traslucenza 30,5 %
Temperatura de sinterización 1500°C	Température de frittage 1500°C	Temperatura di sinterizzazione 1500°C

 Kuraray Noritake Dental Inc.
1621 Sakazu, Kurashiki, Okayama 710-0801, Japan

 0120

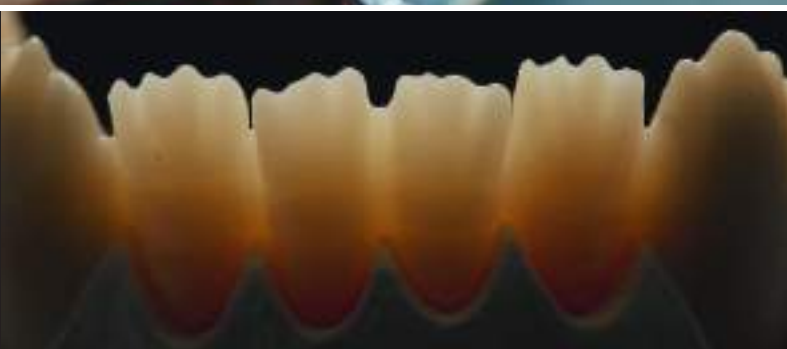

OPERA SYSTEM VIVA ST-ML

ZIRCONIA SÚPERTRANSLÚCIDA & ML ■ ZIRCONIUM SUPER TRANSLUCIDE & ML ■ ZIRCONIA SUPER TRASLUCIDA & MULTI-STRATI



ES Con la gama Zirconia ST-ML, la luz se transmite en el área incisal y se bloquea en el área cervical. Podrá elaborar bonitas prótesis de contorno completo, sin importar del color del pilar. Ideal para puentes posteriores de hasta 3 unidades con una combinación equilibrada de translucidez cromática y gradacional, que reproduce los efectos estéticos del esmalte y la dentina.

FR Avec la gamme Viva ST-ML, la lumière passe dans la zone incisive, mais elle est bloquée dans la zone cervicale. Vous disposez donc de la flexibilité nécessaire pour réaliser des prothèses complètes superbes - quelle que soit la couleur du pilier. Idéal pour les bridges postérieurs jusqu'à 3 unités ; doté d'une gamme complète de translucidité chromatique et graduelle qui reproduit l'esthétique de l'émail et de la dentine.

IT Con la gamma Viva ST-ML, la luce passa nell'area incisale, ma viene bloccata nell'area cervicale. Quindi avete la flessibilità di realizzare protesi totali superbe, indipendentemente dal colore della componente secondaria. Ideale per ponti posteriori fino a 3 unità; Caratterizzato da una gamma completa di traslucidità cromatiche e graduali che riproducono l'estetica dello smalto e della dentina.

Ant.corona
Couronne Ant.
Corone Ant.

Post.corona
Couronne Post.
Corone Post.

Bridge⁽¹⁾
Bridge⁽¹⁾
Ponti⁽¹⁾

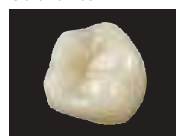

⁽¹⁾Solo se permite un pòntico entre dos pilares. Para colocar dos pònticos consecutivos, recomendamos usar zirconia Viva ML o HT.

⁽¹⁾Un inter maximum consenti entre 2 piliers. Pour 2 inters consécutifs, nous recommandons l'utilisation des zircons Viva ML ou HT.

⁽¹⁾Ponti : 1 pontic intermedio massimo tra 2 monconi. Per 2 pontic intermedi raccomandiamo l'utilizzazione della zirconia ML o HT

A1	14 mm	OS5 5122 / 14
A1	18 mm	OS5 5133 / 18
A1	22 mm	OS5 5144 / 22
A2	14 mm	OS5 5152 / 14
A2	18 mm	OS5 5163 / 18
A2	22 mm	OS5 5174 / 22
A3	14 mm	OS5 5182 / 14
A3	18 mm	OS5 5193 / 18
A3	22 mm	OS5 5204 / 22
A3,5	14 mm	OS5 5212 / 14
A3,5	18 mm	OS5 5223 / 18
A3,5	22 mm	OS5 5234 / 22

A4	14 mm	OS5 5239 / 14
A4	18 mm	OS5 5243 / 18
A4	22 mm	OS5 5254 / 22
B1	14 mm	OS5 5262 / 14
B1	18 mm	OS5 5273 / 18
B1	22 mm	OS5 5284 / 22
B2	14 mm	OS5 5292 / 14
B2	18 mm	OS5 5303 / 18
B2	22 mm	OS5 5314 / 22
B3	14 mm	OS5 5322 / 14
B3	18 mm	OS5 5333 / 18
B3	22 mm	OS5 5344 / 22

C1	14 mm	OS5 5352 / 14
C1	18 mm	OS5 5363 / 18
C1	22 mm	OS5 5374 / 22
C2	14 mm	OS5 5382 / 14
C2	18 mm	OS5 5393 / 18
C2	22 mm	OS5 5404 / 22
C3	14 mm	OS5 5412 / 14
C3	18 mm	OS5 5423 / 18
C3	22 mm	OS5 5434 / 22
D2	14 mm	OS5 5442 / 14
D2	18 mm	OS5 5453 / 18
D2	22 mm	OS5 5464 / 22



D3	14 mm	OS5 5472 / 14
D3	18 mm	OS5 5483 / 18
D3	22 mm	OS5 5494 / 22
NW	14 mm	OS5 3242 / 14
NW	18 mm	OS5 3253 / 18
NW	22 mm	OS5 3264 / 22

VITA® registered trademark of VITA Zahnfabrik H. Rauter GmbH & Co.





Kadara™ Zirconia SF-M - Kuraray Noritake Dental
Stained with CERABOND™ ZR External Stain

 CARACTERÍSTICAS	 CARACTÉRISTIQUES	 CARATTERISTICHE
Resistencia a la flexión 748 Mpa	Résistance à la flexion 748 Mpa	Resistenza alla flessione 748 Mpa
Expansión térmica (25-500°C) 9.8	Expansion thermique (25-500°C) 9.8	Espansione termica (25-500°C) 9.8
Composición ZrO ₂ + HfO ₂ , Y ₂ O ₃ etc.	Composition ZrO ₂ + HfO ₂ , Y ₂ O ₃ etc.	Composizione ZrO ₂ + HfO ₂ , Y ₂ O ₃ etc.
Translucidez 38 %	Transparence 38 %	Traslucenza 38 %
Temperatura de sinterización 1550°C	Température de frittage 1550°C	Temperatura di sinterizzazione 1550°C

 Kuraray Noritake Dental Inc.
1621 Sakazu, Kurashiki, Okayama 710-0801, Japan

 0120



OPERA SYSTEM VIVA UT-ML

ZR MULTICAPAS Y SÚPER TRANSLÚCIDA ■ ZR ULTRA-TRANSLUCIDE & MULTICOUCHE ■ ZR MULTI-STRATI



La zirconia Viva UT-ML es tan translúcida que la luz alcanza el color original del diente: efecto natural en la zona incisal. Efecto tintado en todos los discos (20 tonos 16 + 4 esmaltes) para circonitas completas; La colocación en capas sin revestimiento es posible con porcelana CZR Noritake; Ahorra una cantidad de tiempo considerable (sin inmersión/sin secado); Todos los tonos VITA* Classic están representados; Resistencia a la flexión: 557MPa- La dureza es un 50% inferior a una zirconia convencional.

Viva UT-ML est tellement translucide que la lumière atteint la couleur de la dent originale : effet naturel sur le bord incisal. Des disques pré-teintés dans la masse (20 teintes 16 + 4 émail) pour des monolithiques sans stratification ; Possibilité de stratification sans liner avec la CZR Noritake ; Gain de temps considérable (Ø trempage/Ø séchage) ; Couverture totale du teintier VITA* classique ; Résistance à la flexion : 557 MPa inférieure de 50 % à celle d'une zircone classique.

Viva UT-ML è così traslucido che la luce raggiunge il colore del dente originale: effetto naturale sul bordo incisale. Dischi pre-colorati nella massa (20 tinte 16 + 4 smalto) per monolitici senza stratificazione; Possibilità di stratificazione senza rivestimento con CZR Noritake; Notevole risparmio di tempo (Ø immersione / asciugatura); Copertura totale della classica scala colori VITA*; Resistenza alla flessione: 557 MPa 50% in meno rispetto alla zirconia convenzionale.

A1 14 mm OS5 3842 / 14	A3,5 18 mm OS5 3943 / 18	B3 14 mm OS5 4052 / 14	C3 18 mm OS5 4183 / 18
A1 18 mm OS5 3853 / 18	A3,5 22 mm OS5 3945 / 22	B3 18 mm OS5 4063 / 18	C4 14 mm OS5 4202 / 14
A1 22 mm OS5 3855 / 22	A4 14 mm OS5 3962 / 14	B4 14 mm OS5 4082 / 14	C4 18 mm OS5 4213 / 18
A2 14 mm OS5 3872 / 14	A4 18 mm OS5 3973 / 18	B4 18 mm OS5 4093 / 18	D2 14 mm OS5 4232 / 14
A2 18 mm OS5 3883 / 18	A4 22 mm OS5 3975 / 22	C1 14 mm OS5 4112 / 14	D2 18 mm OS5 4243 / 18
A3 14 mm OS5 3902 / 14	B1 14 mm OS5 3992 / 14	C1 18 mm OS5 4123 / 18	D3 14 mm OS5 4262 / 14
A3 18 mm OS5 3913 / 18	B1 18 mm OS5 4003 / 18	C2 14 mm OS5 4142 / 14	D3 18 mm OS5 4273 / 18
A3 22 mm OS5 3915 / 22	B2 14 mm OS5 4022 / 14	C2 18 mm OS5 4153 / 18	D4 14 mm OS5 4292 / 14
A3,5 14 mm OS5 3932 / 14	B2 18 mm OS5 4033 / 18	C3 14 mm OS5 4172 / 14	D4 18 mm OS5 4303 / 18

*VITA® registered trademark of VITA Zahnfabrik H. Rauter GmbH & Co.

UT-ML EA1 - EA2 - EA3 - ENW son tonos de esmalte diseñados en particular para carillas
 Les teintes **UT-ML EA1 - EA2 - EA3 - ENW** sont conçues spécialement pour les facettes
UT-ML EA1 - EA2 - EA3 - ENW dedicate in particolare alla realizzazione di faccette.

EA1 14 mm OS5 3302 / 14	EA2 14 mm OS5 3332 / 14	EA3 14 mm OS5 3362 / 14	ENW 14 mm OS5 3392 / 14
EA1 18 mm OS5 3313 / 18	EA2 18 mm OS5 3343 / 18	EA3 18 mm OS5 3373 / 18	ENW 18 mm OS5 3403 / 18
			ENW 22 mm OS5 3405 / 22

Carilla
Inlay/Onlay



Veneer
Facette
Faccette



Ant.corona
Couronne Ant.
Corone Ant.

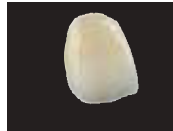

Post.corona
Couronne Post.
Corone Post.

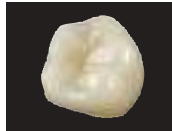

Bridge⁽¹⁾
Bridge⁽¹⁾
Ponti⁽¹⁾



⁽¹⁾Solo se permite un p ntico entre dos pilares. Para colocardos p nticos consecutivos, recomendamos usar zirconia Viva ML o HT.
⁽¹⁾Un inter maximum consenti entre 2 piliers. Pour 2 inters cons cutifs, nous recommandons l'utilisation des zircons Viva ML ou HT.
⁽¹⁾Ponti : 1 pontic intermedio massimo tra 2 monconi. Per 2 pontic intermedi raccomandiamo l'utilizzazione della zirconia ML o HT

Teintes standard
De A1   D4



Teintes Email
(ENW, EA1, EA2, EA3)



Estructura de 4 capas
D grad  dans la masse compos  de 4 couches
Degradato nella massa in 4 strati



CARACTERÍSTICAS

Resistencia a la flexi n
557 Mpa

Expansi n t rmica (25-500 C)
9.7

Composici n
ZrO₂ + HfO₂, Y₂O₃ etc.

Translucidez
43.3 %

Temperatura de sinterizaci n
1550 C



CARACT RISTIQUES

R sistance   la flexion
557 Mpa

Expansion thermique (25-500 C)
9.7

Composition
ZrO₂ + HfO₂, Y₂O₃ etc.

Transparence
43.3 %

Temp rature de frittage
1550 C



CARATTERISTICHE

Resistenza alla flessione
557 Mpa

Espansione termica (25-500 C)
9.7

Composizione
ZrO₂ + HfO₂, Y₂O₃ etc.

Traslucenza
43.3 %

Temperatura di sinterizzazione
1550 C

 Kuraray Noritake Dental Inc.
1621 Sakazu, Kurashiki, Okayama 710-0801, Japan

 0120



OPERA SYSTEM WAX



CERA SINTÉTICA ■ CIRE SYNTHÉTIQUE ■ DISCHI DI CERA SINTETICA







La cera se utiliza para la elaboración rápida de modelos para todos los trabajos con moldes. Gracias a la tecnología CAD / CAM, los modelos elaborados son precisos y respetan todos los detalles del elemento que se desea elaborar, incluso el más pequeño. Las características de procesamiento excelentes están garantizadas por el color opaco. **Inodoro, muy fácil de fresar, no se hincha durante el fresado, no produce residuos cuando se quema, estabilidad volumétrica. Producción media: hasta 30 elementos.**

La cire est utilisée pour la réalisation rapide de maquette pour tous les travaux de coulée. Grâce à la technologie CFAO les maquettes réalisées sont précises et respectent tous les détails de l'élément à réaliser, même les plus infimes. Une netteté maximale des contours est garantie grâce à la couleur opaque des disques Opera System Wax. **Inodore, Usinage facile, Calcinable sans laisser de résidus, Stabilité volumétrique. Production moyenne : jusqu'à 30 éléments.**

La cera viene utilizzata per la rapida realizzazione del modello per tutte le opere di fusione. Grazie alla tecnologia CAD / CAM, i modelli realizzati sono precisi e rispettano tutti i dettagli dell'elemento da realizzare, anche i più piccoli. La massima nitidezza dei bordi è garantita dal colore opaco dei dischi Opera System Wax. **Inodore, Facile da lavorare, Calcinabile senza lasciare residui, Stabilità volumetrica. Produzione media: fino a 30 elementi.**

 CARACTERÍSTICAS	 CARACTÉRISTIQUES	 CARATTERISTICHE
Composición Cera sintética	Composition Cire synthétique	Composizione Cera sintetica
Solubilidad en agua Insoluble	Solubilité dans l'eau Non soluble	Solubilità nell'acqua Non soluble
Punto de fusión 100-130°C	Point de fusion 100-130°C	Punto di fusione 100-130°C
Densidad 0,97 g/cm ³	Densité 0,97 g/cm ³	Densità 0,97 g/cm ³
Olor Inodora	Odeur Inodore	Odore Inodore

	BLUE	14 mm	OS5 500 32
	BLUE	20 mm	OS5 500 33
	GREY	14 mm	OS5 500 30
	GREY	20 mm	OS5 500 31

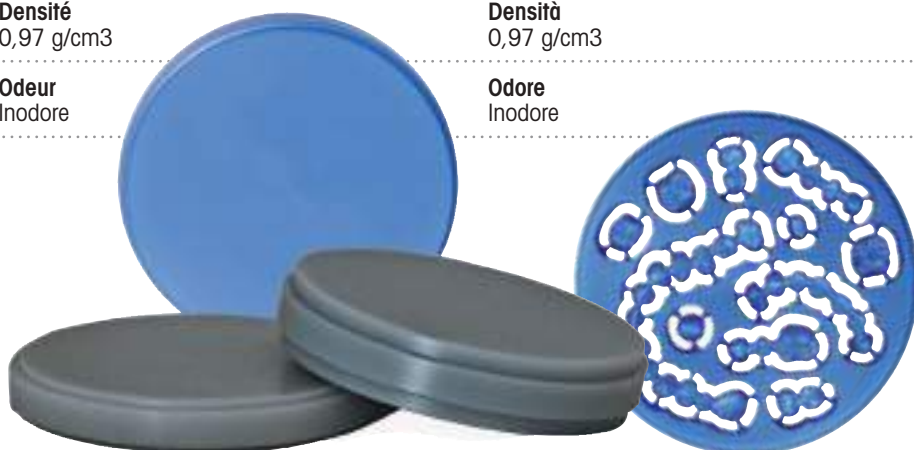

OPERA SYSTEM PMMA IDODENTINE

CAD-CAM BLANKS IN PMMA ■ DISQUE CAD-CAM EN PMMA ■ DISCHI PMMA































CE 0120

 Polímero acrílico basado en polimetilmetacrilato - **1, 2, 3 o 5 capas de diferentes colores** - El PMMA protege al antagonista - 100% de pigmentos minerales para una coloración inalterable - Fluorescencia similar a los dientes naturales - 100% biocompatible

 Polymère acrylique à base de polyméthacrylate de méthyl - **1, 3 ou 5 couches de couleurs différentes** - Le PMMA protège la dent antagoniste - Pigments 100 % minéraux pour une coloration inaltérable - Fluorescence similaire aux dents naturelles - 100% biocompatible

 Polimero acrilico a base di polimetilmetacrilato - **1, 2, 3 o 5 strati di colore diversi** - Il pmma protegge l'antagonista - 100% pigmenti minerali per una colorazione inalterabile - Fluorescenza simile ai denti naturali - Biocompatibile al 100%

 CARACTERÍSTICAS	 CARACTÉRISTIQUES	 CARATTERISTICHE
Resistencia a la flexión Aproximadamente 90 MPa	Résistance à la flexion Approximativement 90 MPa	Resistenza a flessione Circa 90 MPa
Dureza Aproximadamente 200	Dureté Approximativement 200	Durezza Circa 200
Punto de Vicat >100°C	Vicat point >100°C	Vicat point >100°C
Absorción de agua Aproximadamente 25 microgramos / mm ³	Absorbition de l'eau Approximativement 25 microgrammes / mm ³	Assorbimento d'acqua Circa 25 microgrammi / mm ³
Solubilidad Aproximadamente 0 microgramos / mm ³	Solubilité Approximativement 0 microgrammes / mm ³	Solubilità Circa 0 microgrammi / mm ³
Densidad 1,18 g / cm ³	Densité 1,18 g / cm ³	Densità 1,18 g / cm ³

1 capa / couche / strato :	 A1 16 mm 4252/A1	 BG3* 12 mm 4254/BG3	 C2 16 mm 4300/C2
 A3 16 mm 4252/A3	 A1 12 mm 4254/A1	 BG3* 20 mm 4250/BG3	5 capas / couches / strati :
 A3 12 mm 4254/A3	 A1 20 mm 4250/A1	3 capas / couches / strati :	 A3 20 mm 4500/A3
 A3 20 mm 4250/A3	 B1 16 mm 4252/B1	 A3 16 mm 4300/A3	 A2 20 mm 4500/A2
 A2 16 mm 4252/A2	 B1 12 mm 4254/B1	 A2 16 mm 4300/A2	 A1 20 mm 4500/A1
 A2 12 mm 4254/A2	 B1 20 mm 4250/B1	 A1 16 mm 4300/A1	 B3 20 mm 4500/B3
 A2 20 mm 4250/A2	 BG3* 16 mm 4252/BG3	 B3 16 mm 4300/B3	 C2 20 mm 4500/C2

VITA® registered trademark of VITA Zahnfabrik H. Rauter GmbH & Co. * BG3, blanqueado grado 3 (más blanco que A1) - BG3, grade 3 de blanchiment (plus blanc que A1) - BG3, grado 3 sbiancato (più bianco di A1)

OPERA SYSTEM PMMA

DISCOS CAD-CAM EN PMMA ■ DISQUE CAD-CAM EN PMMA ■ DISCHI PMMA



Los discos de PMMA son adecuados para el procesamiento temporal de coronas y puentes, férulas bucales y para verificar los ajustes de puente/modelo. El PMMA permite fabricar los elementos provisionales para prótesis de transición.

Les disques PMMA permettent la fabrication de couronnes et de bridges à la teinte souhaitée, et de vérifier les ajustages du bridge sur le modèle en plâtre ou à l'essayage en bouche avant le processus de fraisage final. Le PMMA permet de fabriquer les provisoires pour des prothèses de transition.

I dischi in PMMA consentono la produzione di corone e ponti nella tonalità desiderata, oltre al controllo del raccordo a ponte sul modello in gesso o nel raccordo in bocca prima del processo di fresatura finale. PMMA rende possibile la produzione di provvisori per protesi di transizione.

ES CARACTERÍSTICAS	FR CARACTÉRISTIQUES	IT CARATTERISTICHE
Resistencia a la flexión 114 MPa	Résistance à la flexion 114 MPa	Resistenza a flessione 114 MPa
Dureza Vickers 26,60 HV	Dureté Vickers 26,60 HV	Durezza Vickers 26,60 HV
E-Module 2771 MPa	E-Module 2771 MPa	E-Module 2771 MPa
Monómero residual <1%	Monomer Residuel <1%	Monomero residuo <1%
Composición Polimetilmetacrilato puro	Composition Polymethylmethacrylate pur	Composizione Polymethylmethacrylate puro
Punto de ignición >250°C	Flash point >250°C	Flash point >250°C
Densidad 1,17 g / cm3	Densité 1,17 g / cm3	Densità 1,17 g / cm3
A1 12 mm OS 500 50	A2 12 mm OS 500 55	A3 12 mm OS 500 60
A1 14 mm OS 500 51	A2 14 mm OS 500 56	A3 14 mm OS 500 61
A1 18 mm OS 500 52	A2 18 mm OS 500 57	A3 18 mm OS 500 62
A1 20 mm OS 500 53	A2 20 mm OS 500 58	A3 20 mm OS 500 63
A1 25 mm OS 500 54	A2 25 mm OS 500 59	A3 25 mm OS 500 64
B1 12 mm OS 500 65		B1 12 mm OS 500 65
B1 14 mm OS 500 66		B1 14 mm OS 500 66
B1 18 mm OS 500 67		B1 18 mm OS 500 67
B1 20 mm OS 500 68		B1 20 mm OS 500 68
B1 25 mm OS 500 69		B1 25 mm OS 500 69

OPERA SYSTEM PMMA PINK

DISCOS CAD-CAM EN PMMA ■ DISQUE CAD-CAM EN PMMA ■ DISCHI PMMA



CE 0470

Los discos rosados se pueden utilizar para fresar modelos de prótesis estéticos y funcionales. Los discos se pueden usar para la carga inmediata del implante protésico como un elemento provisional a largo plazo en combinación con dientes artificiales y conectores de titanio.



Aplicaciones: dentaduras postizas completas, parciales, implantes temporales para manipulación inmediata.



Les disques CAD-CAM Pink sont utilisés pour usiner des modélisations hautement esthétiques et des prothèses très fonctionnelles. Les disques peuvent être utilisés pour le chargement immédiat de l'implant prothétique comme un provisoire de longue durée en combinaison avec les dents artificielles et des connecteurs titane.

Indications : Prothèses complètes, Prothèses partielles, Prothèses temporaires implantaires pour prise en charge immédiate.

I dischi CAD-CAM Pink sono utilizzati per produrre modelli altamente estetici e protesi altamente funzionali. I dischi possono essere utilizzati per la produzione immediata di un impianto protesico come un provvisorio a lunga durata combinati a denti artificiali e connettori in titanio.

indicato per : protesi complete, protesi parziali, protesi implantari provvisorie per l'installazione immediata.

 CARACTERÍSTICAS	 CARACTÉRISTIQUES	 CARATTERISTICHE
Resistencia a la flexión 114 MPa	Résistance à la flexion 114 MPa	Resistenza alla flessione 114 MPa
Dureza Vickers 26,60 HV	Dureté Vickers 26,60 HV	Durezza Vickers 26,60 HV
E-Module 2771 MPa	E-Module 2771 MPa	E-Module 2771 MPa
Monómero residual <1%	Monomer Residuel <1%	Monomero residuo <1%
Composición polimetilmetacrilato + pigmentos	Composition polymethylmethacrylate + pigments	Composizione polymethylmethacrylate + pigmenti
Punto de ignición >250°C	Flash point >250°C	Flash point >250°C
Densidad 1,17 g / cm ³	Densité 1,17 g / cm ³	Densità 1,17 g / cm ³

	PINK	25 mm	OS5 500 75
	PINK	27 mm	OS5 500 76
	PINK	30 mm	OS5 500 77



OPERA SYSTEM PMMA TR



PMMA TRANSPARENTE ■ PMMA TRANSPARENT ■ PMMA TRASPARENTE



 El disco PMMA TRANSPARENTE se ha fabricado con material 100 % orgánico, inodoro.
Aplicaciones: férulas de mordida, férulas de mordida antirronquidos y cerámica prensada.

 Le disque PMMA TRANSPARENT est composé à 100 % de matière organique, inodore.
Indications : Fabrication de Gouttières, Gouttières anti-ronflement, Céramique pressée.

 Il disco CAD-CAM PMMA TRASPARENTE è composto al 100% da sostanza organica, inodore.
Indicato per : Fabbricazione di bite, bite notturni, ceramiche pressate.

 CARACTERÍSTICAS	 CARACTÉRISTIQUES	 CARATTERISTICHE
Resistencia a la flexión 114 MPa	Résistance à la flexion 114 MPa	Resistenza alla flessione 114 MPa
Dureza Vickers 26,60 HV	Dureté Vickers 26,60 HV	Durezza Vickers 26,60 HV
E-Module 2771 MPa	E-Module 2771 MPa	E-Module 2771 MPa
Composición Polymethylmethacrylate	Composition Polymethylmethacrylate	Composizione Polymethylmethacrylate
Punto de ignición >250°C	Flash point >250°C	Flash point >250°C
Densidad 1,17 g / cm ³	Densité 1,17 g / cm ³	Densità 1,17 g / cm ³





	TRANS	12 mm	OS5 500 70
	TRANS	14 mm	OS5 500 71
	TRANS	18 mm	OS5 500 72
	TRANS	20 mm	OS5 500 73
	TRANS	25 mm	OS5 500 74

OPERA SYSTEM **CAST**



CALCINABLE ■ CALCINABLE ■ CALCINABILI







 Los discos CAD-CAM CAST son adecuados para marcos de moldes, fundir metales y cerámica prensada. No producen residuos cuando se queman. Inodoros y transparentes. Producto fabricado de materia 100% orgánica. Verificación de estructuras en el modelo de yeso / en boca antes del fresado final de ZrO₂ (especialmente recomendado para estructuras de ZrO₂ más grandes).

 Les disques CAD-CAM CAST sont indiqués pour la coulée de tout type d'armature ou céramique pressée. Pas de résidus après cuisson. Inodore et transparent. Produit composé à 100% de matière organique. Pour vérification du bridge sur le modèle en plâtre modèle avant le processus de fraisage (particulièrement recommandé pour les armatures en zircone longue portée).

 I dischi CAD-CAM CAST sono indicati per la fusione di qualsiasi tipo di sottostrutture o ceramiche pressate. Nessun residuo dopo la cottura. Inodore e trasparente. Prodotto composto al 100% da sostanza organica. Per il verifica del ponte sul modello in gesso prima del processo di fresatura (particolarmente raccomandato per le sottostrutture in zirconia).

 CARACTERÍSTICAS	 CARACTÉRISTIQUES	 CARATTERISTICHE
Resistencia a la flexión 114 MPa	Résistance à la flexion 114 MPa	Resistenza alla flessione 114 MPa
Dureza Vickers 26,60 HV	Dureté Vickers 26,60 HV	Durezza Vickers 26,60 HV
E-Module 2771 MPa	E-Module 2771 MPa	E-Module 2771 MPa
Composición Polymethylmethacrylate	Composition Polymethylmethacrylate	Composizione Polymethylmethacrylate
Punto de ignición >250°C	Flash point >250°C	Flash point >250°C
Densidad 1,17 g / cm ³	Densité 1,17 g / cm ³	Densità 1,17 g / cm ³



 CAST 12 mm OS5 500 01
 CAST 15 mm OS5 500 02
 CAST 20 mm OS5 500 03
 CAST 25 mm OS5 500 04
 CAST 30 mm OS5 500 05

OPERA SYSTEM X-RAY

RADIO-OPACO ■ RADIO-OPAQUE ■ RADIO-OPACO



CE 0470



 Los discos radio opacos se pueden usar para el diagnóstico de fresado durante la planificación del implante. La mezcla homogénea garantiza la mejor visibilidad. Previene la dispersión de la luz.

 Les disques CAD/CAM X-Ray sont des disques radio opaques visibles aux rayons X et utilisés pour l'usage de diagnostics radio-opaques liés à la planification implantaire. Mélange homogène assurant une meilleure visibilité. Empêche la diffusion de la lumière.

 I dischi X-RAY CAD/CAM sono dischi opacizzati visualizzabili ai raggi X e utilizzati per la pianificazione implantare. Miscela omogenea che garantisce una migliore visibilità. Previene il riverbero della luce.

 CARACTERÍSTICAS	 CARACTÉRISTIQUES	 CARATTERISTICHE
Resistencia a la flexión 89 MPa	Résistance à la flexion 89 MPa	Resistenza alla flessione 89 MPa
E-Module 3236 MPa	E-Module 3236 MPa	E-Module 3236 MPa
Densidad 1,3 Kg / l	Densité 1,3 Kg / l	Densità 1,3 Kg / l
Composición Polvo visible para rayos X	Composition Poudre radio-opaque	Composizione Polvere radio-opaca



 15 mm	OS5 500 10
 20 mm	OS5 500 11
 25 mm	OS5 500 12

OPERA SYSTEM MODEL

DISCOS MODELO ■ DISQUES POUR MODÈLES ■ DISCHI PER MODELLI



 Los discos CAD-CAM Opera System Model son adecuados para fresar modelos dentales. Muy fáciles de fresar.



Indicaciones: fresado de raigones/cubos, modelos de trabajo y antagonistas. Verificación de estructuras en el modelo de yeso antes del fresado final de ZrO₂ (especialmente recomendado para estructuras de ZrO₂ más grandes).



 Les disques CAD-CAM Opera System Model conviennent pour le Fraisage très facile des modèles dentaires.

Indications : fraisage moignons / dies, modèles de travail et antagonistes. Vérification des armatures sur le modèle en plâtre avant le fraisage final de la zircone (spécialement recommandé pour les armatures en zircone de grande taille).

 I dischi modello CAD-CAM Opera System sono adatti per fresare facilmente i modelli dentali.

Indicatio per : fresatura di monconi, modelli di lavoro e antagonisti. Verifica delle sottostrutture sul modello in gesso prima della fresatura finale della zirconia (particolarmente consigliato per le sottostrutture in zirconia di grandi dimensioni).

 CARACTERÍSTICAS	 CARACTÉRISTIQUES	 CARATTERISTICHE
Temperatura de ignición >350°C	Ignition temperature >350°C	Temperature di fusione >350°C
Límite inferior de explosividad 1,1 vol%	Limite inférieure d'explosion 1,1 vol%	Limite inferiore di esplosione 1,1 vol%
Límite superior de explosividad 8 vol%	Limite d'explosion supérieure 8 vol%	Limite superiore di esplosione 8 vol%
Composición Polyurethane	Composition Polyuréthane	Composizione polyuréthane
Flash point >250°C	Point d'ignition >250°C	Flash point >250°C
Densidad 0.7 g / cm ³	Densité 0.7 g / cm ³	Densità 0.7 g / cm ³

 10 mm	OS5 500 20
 16 mm	OS5 500 21
 25 mm	OS5 500 22

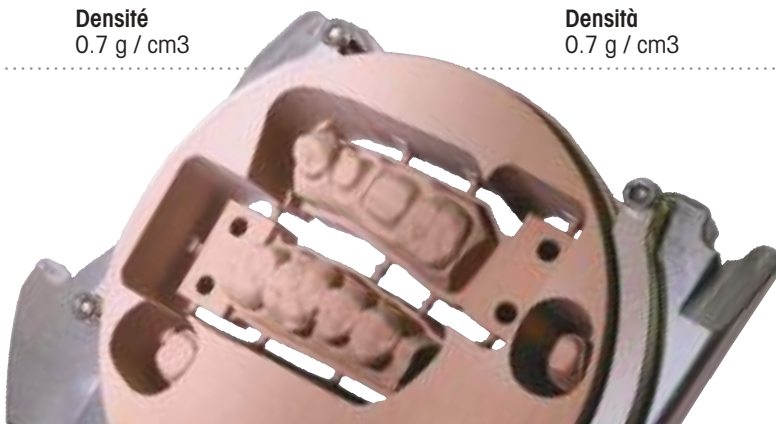

OPERA SYSTEM PEEK

DISCOS PEEK ■ DISQUE PEEK ■ DISCHI PEEK



 Tecnopolímero termoplástico reforzado con alta resistencia a la flexión. Se mecaniza igual que las resinas de forma provisional, es decir, sin lubricación. Su implementación es muy rápida y no es necesaria la cocción para su preparación. Una aplicación cosmética sencilla proporcionará a sus elementos el tono y la belleza necesarios. Encontrará muchas aplicaciones en prótesis fijas y móviles.







Aplicaciones: barra de implante, pilares de escaneo, etc.

 Thermoplastique technopolymer renforcé présentant une haute résistance à la flexion. Il s'usine de la même manière que les résines pour provisoires, c'est à dire sans lubrification. Sa mise en oeuvre est très rapide et aucune cuisson n'est nécessaire à sa préparation. Une simple application de cosmétique donnera à vos éléments la teinte et la beauté nécessaire. Il trouvera de nombreuses applications en prothèse fixe et mobile.

Indications : Barres implantaires, scan abutments, etc.

 IL tecnopolimero termoplastico rinforzato presenta elevata resistenza alla flessione. Viene utilizzato allo stesso modo delle resine provvisorie, ossia senza lubrificazione. La sua posa è molto rapida e non è necessaria nessuna cottura. Una semplice applicazione del cosmetico darà ai vostri elementi la tonalità e la bellezza necessaria. Trova molte applicazioni in protesi fissa e mobile.

Indicatore per : barre implantari, scansioni implantari, ecc.

 14 mm	OS5 500 40	 25* mm	OS5 500 43
 16 mm	OS5 500 41	 30* mm	OS5 500 44
 20 mm	OS5 500 42	 35* mm	OS5 500 45

* Bajo demanda / sur commande / su richiesta

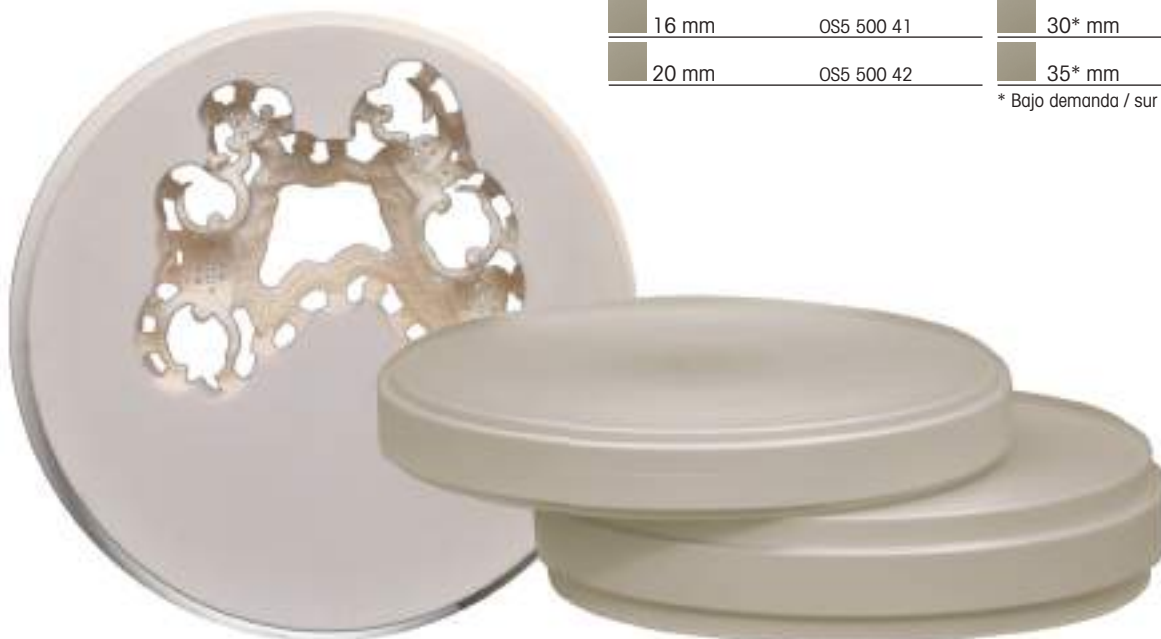

OPERA SYSTEM ACETAL

DISCOS ACETAL ■ DISQUES ACETAL ■ DISCHI ACETAL



ES Tecnopolímero termoplástico con excelente resistencia mecánica. Para coronas temporales y marcos de puentes. Ideal para pacientes alérgicos: excelente biocompatibilidad. Duración intraoral de hasta 4 años. Alta resistencia a la abrasión y al impact - Óptima resistencia a la tensión. Mejora la memoria elástica

Aplicaciones: puentes temporales o infraestructuras para combinar con resina acrílica o PMMA.

FR Thermoplastiques technopolymer avec une excellente résistance mécanique. Pour les couronnes temporaires et les armatures des bridges. Idéal pour les patients allergiques : Biocompatibilité exceptionnelle - Durée intraorale jusqu'à 4 ans - Haute abrasion et résistance aux chocs - Résistance à la traction optimale - Améliore la mémoire élastique

Indications : Bridges provisoires et/ou infrastructures pour correspondre à la résine acrylique ou PMMA.

IT Il tecnopolimero termoplastico con eccellente resistenza meccanica. Per corone provvisorie e sottostrutture di ponti. Ideale per i pazienti allergici: Eccezionale biocompatibilità - Durata intraorale fino a 4 anni - Elevata resistenza all'abrasione e agli urti - Ottima Resistenza a trazione - Migliora la memoria elastica

Indicatio per: ponti provvisori e / o sottostrutture per abbinare resina acrilica o PMMA.

ES CARACTERÍSTICAS	FR CARACTÉRISTIQUES	IT CARATTERISTICHE
Resistencia a la flexión 88 MPa	Résistance à la flexion 88 MPa	Resistenza alla flessione 88 MPa
E-module 3,536 MPa	E-module 3,536 MPa	E-module 3,536 MPa
Elasticidad 40 MPa	Elasticité 40 MPa	Elasticità 40 MPa
Tensión de rotura [A5 %] 5,2	Contrainte de rupture [A5 %] 5,2	Rottura allo stress [A5 %] 5,2
Composición Tecnopolímero de acetel (POM)	Composition Acetel technopolymer (POM)	Composizione Acetel technopolymer (POM)

A 16 mm 005519816	A2 16 mm 005539816	B1 16 mm 005579816	F1* 25 mm 005689825
A 20 mm 005519820	A2 20 mm 005539820	B1 20 mm 005578820	*F1= encía / gencive / gengiva
A1 16 mm 005529816	A3 16 mm 005549816	B2 16 mm 005589816	
A1 20 mm 005529820	A3 20 mm 005549820	B2 20 mm 005589820	



Especialistas de producto

David Carralero
+34 697 41 42 59

Francisco del Rio
+34 609 426 623



Distribuidor en España y Portugal:

Incotrading S.A.

Camino de Hormigueras, 119-121,
Pol. Ind. de Vallecas, 28031 Madrid (España)
T. (+34) 913 807 490

incotrading@incotrading.net
www.incotrading.net

incotrading

Tecnología para la salud

